

DATE CREATED		REVISIONS		
REV	DESCRIPTION	APPROVED		
7/24/18	00	Revised from PSC-4056_09		R.C

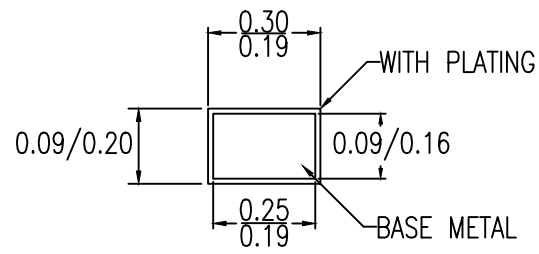
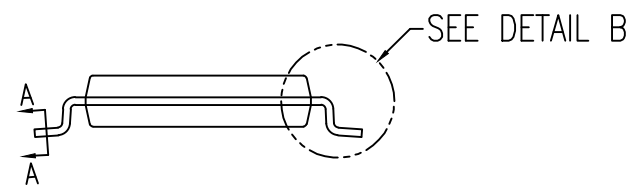
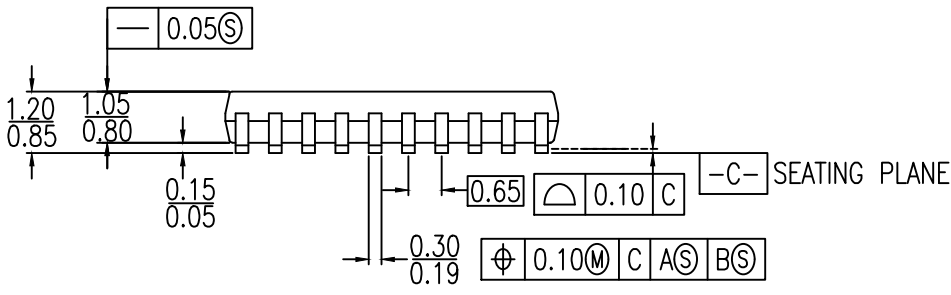
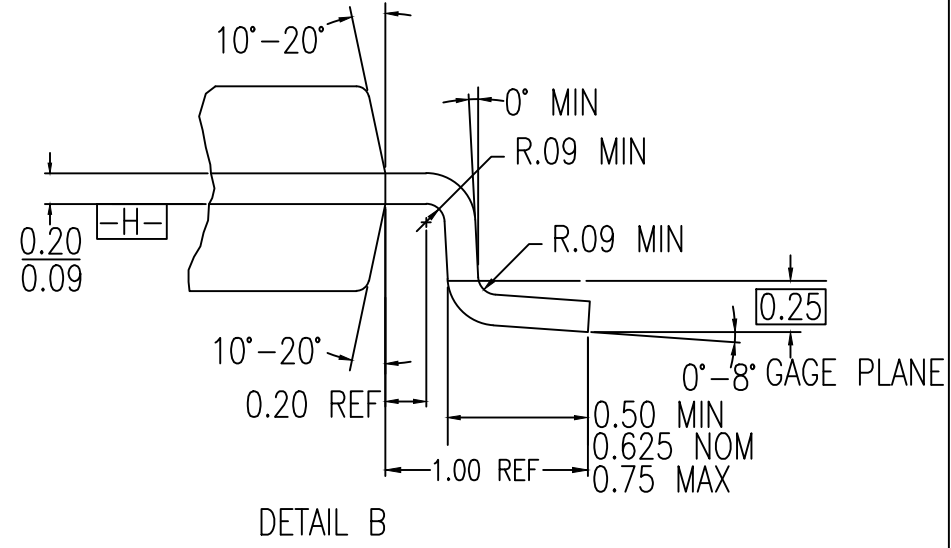
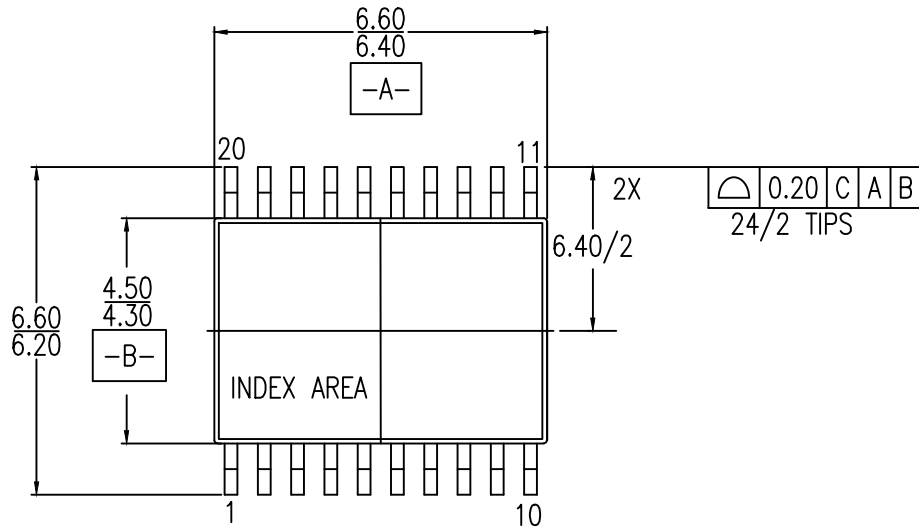

SECTION A-A

NOTES:

1. ALL DIMENSIONING AND TOLERANCING CONFORM TO ANSI Y14.5M-1982
2. ALL DIMENSION ARE IN MM.

TOLERANCES UNLESS SPECIFIED			6024 Silver Creek Valley Rd San Jose, CA 95138 PHONE: (408) 284-8200 FAX: (408) 284-3572 <a href="http://www.IDT.com">www.IDT.com</a>
DECIMAL	ANGULAR		
XX±	±	TITLE PGG20 Package Outline Drawing 4.4 mm Body, 0.65mm Pitch TSSOP	
XXX±		SIZE C	DRAWING No. PSC-4770
XXXX±			REV 00
DO NOT SCALE DRAWING			SHEET 1 OF 2

DATE CREATED		REVISIONS		
DATE CREATED	REV	DESCRIPTION	APPROVED	
7/24/18	00	Revised from PSC-4056_09	R.C	

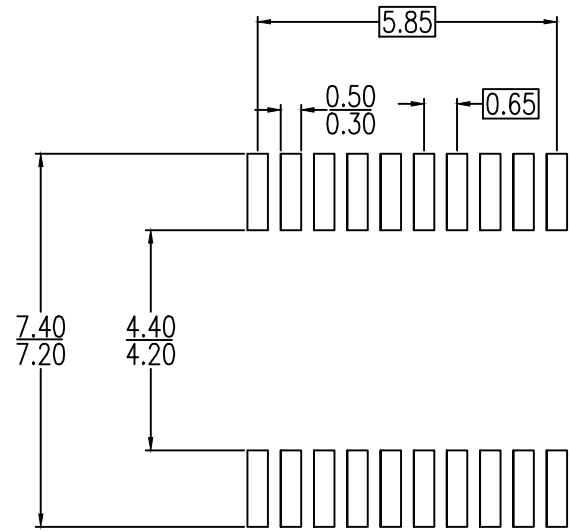

RECOMMENDED LAND PATTERN DIMENSIONS

NOTES:

1. ALL DIMENSIONS ARE IN MILLIMETERS

TOLERANCES UNLESS SPECIFIED		 6024 Silver Creek Valley Rd San Jose, CA 95138 PHONE: (408) 284-8200 FAX: (408) 284-3572 www.IDT.com
DECIMAL	ANGULAR	
XX±	±	
XXX±		
XXXX±		
TITLE		PGG20 Package Outline Drawing
		4.4 mm Body, 0.65mm Pitch
		TSSOP
SIZE	DRAWING No.	REV
C	PSC-4770	00
DO NOT SCALE DRAWING		SHEET 2 OF 2