

Description

The 9ZXL1930D / 9ZXL1950D are second-generation, enhanced-performance DB1900Z-derivative differential buffers. The parts are pin-compatible upgrades to the 9ZXL1930B and 9ZXL1950B, while offering a much improved phase jitter performance. A fixed external feedback maintains low drift for critical QPI/UPI applications. In fanout mode, the devices meet the DB2000Q additive phase jitter specification.

PCIe Clocking Architectures

- Common Clocked (CC)
- Independent Reference (IR) with and without spread spectrum

Typical Applications

- Servers
- Storage
- Networking
- SSDs

Output Features

- 19 Low-Power HCSL (LP-HCSL) output pairs (1930D)
- 19 Low-Power HCSL (LP-HCSL) output pairs with 85Ω Zout (1950D)

Block Diagram

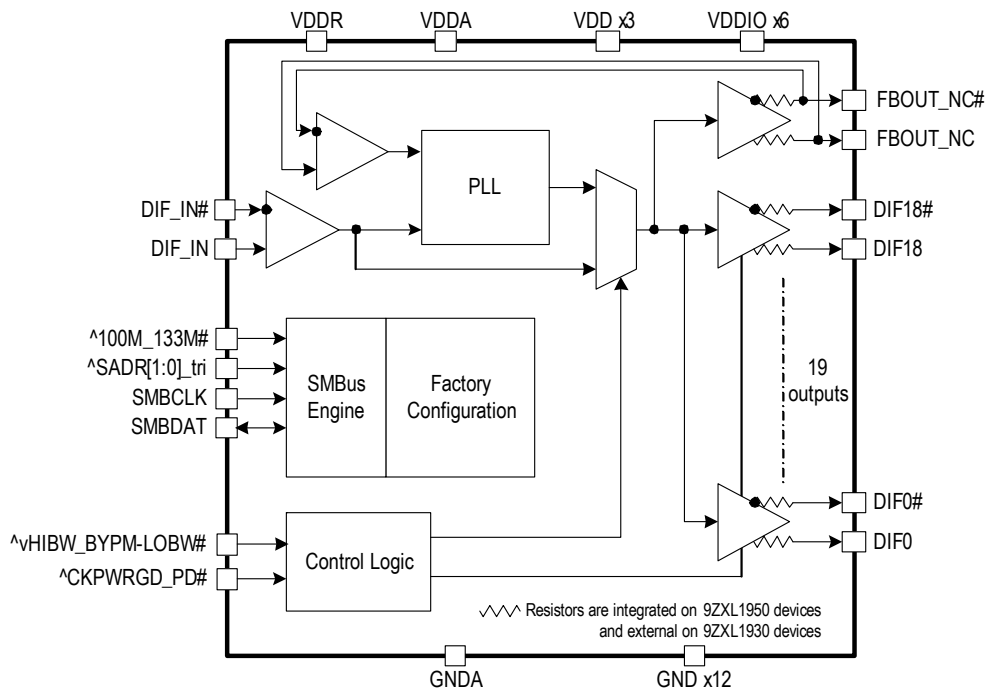

Features

- LP-HCSL outputs; eliminate 38 resistors, save 65mm² of area (1930D)
- LP-HCSL outputs with 85Ω Zout; eliminate 76 resistors, save 130mm² of area (1950D)
- SMBus OE bits; software control of each output
- 9 selectable SMBus addresses; multiple devices can share the same SMBus segment
- Selectable PLL BW; minimizes jitter peaking in cascaded PLL topologies
- Hardware/SMBus control of PLL bandwidth and bypass; change mode without power cycle
- Spread spectrum compatible; tracks spreading input clock for EMI reduction
- 10 × 10 mm 72-VFQFPN package; small board footprint

Key Specifications

- Cycle-to-cycle jitter: < 50ps
- Output-to-output skew: < 50ps
- Input-to-output delay: fixed at 0ps
- Input-to-output delay variation: < 50ps
- Additive phase jitter: PCIe Gen4 < 53fs rms
- Additive phase jitter: IF-UPI < 70fs rms
- Additive phase jitter: DB2000Q filter < 80fs rms

Contents

Description	1
PCIe Clocking Architectures	1
Typical Applications	1
Output Features	1
Features	1
Key Specifications	1
Block Diagram	1
Pin Assignments	3
Pin Descriptions	3
Absolute Maximum Ratings	6
Electrical Characteristics	7
Clock Periods	14
Functionality at Power-Up (PLL Mode)	15
Test Loads	16
Package Outline Drawings	20
Ordering Information	20
Revision History	21

Pin Assignments

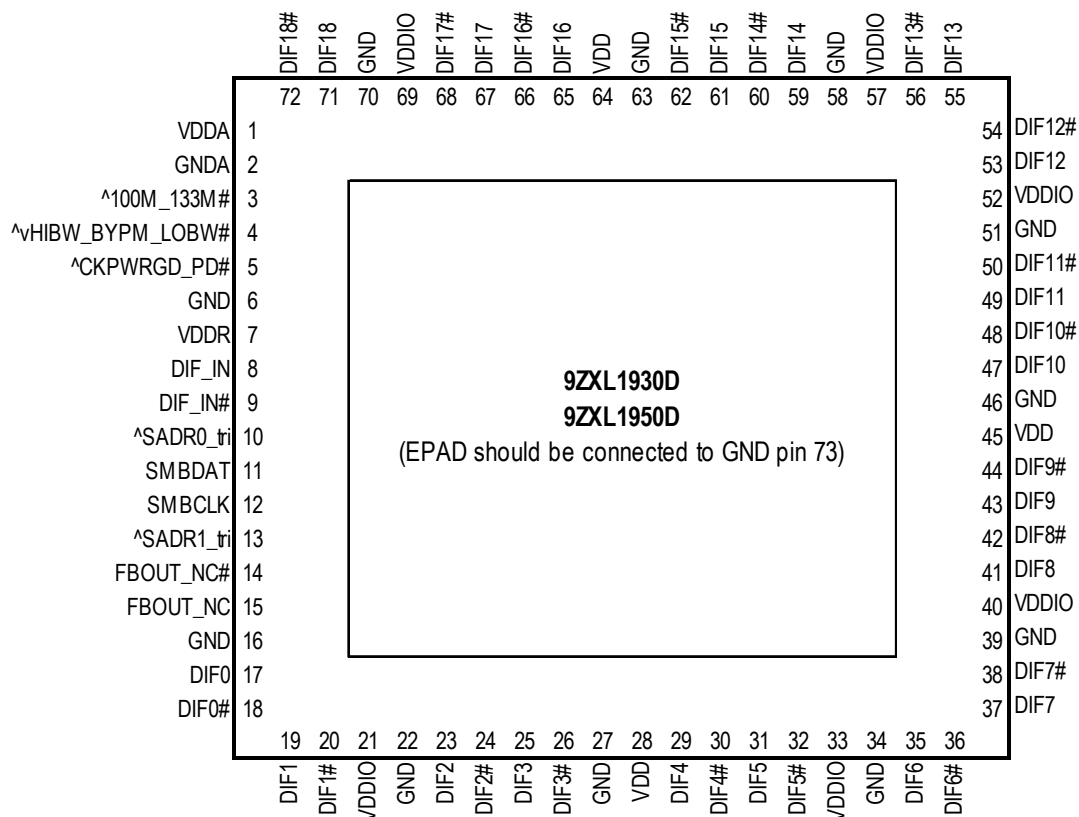

10 x 10 mm 72-VFQFPN

- Notes: Pins with ^ prefix have internal 120kohm pull-up
 Pins with v prefix have internal 120kohm pull-down
 Pins with ^v prefix have internal 120kohm pull-up/pull-down (biased to VDD/2)

Pin Descriptions

Table 1. Pin Descriptions

Number	Name	Type	Description
1	VDDA	Power	Power supply for PLL core.
2	GNDA	GND	Ground pin for the PLL core.
3	^100M_133M#	Latched In	3.3V input to select operating frequency. This pin has an internal 120kΩ pull-up resistor. See <i>Functionality at Power-Up</i> table for definition.
4	^vHIBW_BYPM_LOBW#	Latched In	Tri-level input to select High BW, Bypass or Low BW mode. This pin is biased to $V_{DD}/2$ (Bypass Mode) with internal pull-up/pull-down resistors. See <i>PLL Operating Mode</i> table for details.
5	^CKPWRGD_PD#	Input	Input notifies device to sample latched inputs and start up on first high assertion. Low enters power-down mode, subsequent high assertions exit power-down mode. This pin has an internal 120kΩ pull-up resistor.
6	GND	GND	Ground pin.
7	VDDR	Power	Power supply for differential input clock (receiver). This V_{DD} should be treated as an analog power rail and filtered appropriately. Nominally 3.3V.

Table 1. Pin Descriptions (Cont.)

Number	Name	Type	Description
8	DIF_IN	Input	HCSL true input.
9	DIF_IN#	Input	HCSL complementary input.
10	^SADR0_tri	Input	SMBus address bit. This is a tri-level input that works in conjunction with other SADR pins, if present, to decode SMBus addresses. It has an internal 120kΩ pull-up resistor. See the <i>SMBus Addressing</i> table.
11	SMBDAT	I/O	Data pin of SMBUS circuitry.
12	SMBCLK	Input	Clock pin of SMBUS circuitry.
13	^SADR1_tri	Input	SMBus address bit. This is a tri-level input that works in conjunction with other SADR pins, if present, to decode SMBus addresses. It has an internal 120kΩ pull-up resistor. See the <i>SMBus Addressing</i> table.
14	FBOUT_NC#	Output	Complementary half of differential feedback output. This pin should NOT be connected to anything outside the chip. It exists to provide delay path matching to get 0 propagation delay.
15	FBOUT_NC	Output	True half of differential feedback output. This pin should NOT be connected to anything outside the chip. It exists to provide delay path matching to get 0 propagation delay.
16	GND	GND	Ground pin.
17	DIF0	Output	Differential true clock output.
18	DIF0#	Output	Differential complementary clock output.
19	DIF1	Output	Differential true clock output.
20	DIF1#	Output	Differential complementary clock output.
21	VDDIO	Power	Power supply for differential outputs.
22	GND	GND	Ground pin.
23	DIF2	Output	Differential true clock output.
24	DIF2#	Output	Differential complementary clock output.
25	DIF3	Output	Differential true clock output.
26	DIF3#	Output	Differential complementary clock output.
27	GND	GND	Ground pin.
28	VDD	Power	Power supply, nominally 3.3V.
29	DIF4	Output	Differential true clock output.
30	DIF4#	Output	Differential complementary clock output.
31	DIF5	Output	Differential true clock output.
32	DIF5#	Output	Differential complementary clock output.
33	VDDIO	Power	Power supply for differential outputs.
34	GND	GND	Ground pin.
35	DIF6	Output	Differential true clock output.
36	DIF6#	Output	Differential complementary clock output.
37	DIF7	Output	Differential true clock output.

Table 1. Pin Descriptions (Cont.)

Number	Name	Type	Description
38	DIF7#	Output	Differential complementary clock output.
39	GND	GND	Ground pin.
40	VDDIO	Power	Power supply for differential outputs.
41	DIF8	Output	Differential true clock output.
42	DIF8#	Output	Differential complementary clock output.
43	DIF9	Output	Differential true clock output.
44	DIF9#	Output	Differential complementary clock output.
45	VDD	Power	Power supply, nominally 3.3V.
46	GND	GND	Ground pin.
47	DIF10	Output	Differential true clock output.
48	DIF10#	Output	Differential complementary clock output.
49	DIF11	Output	Differential true clock output.
50	DIF11#	Output	Differential complementary clock output.
51	GND	GND	Ground pin.
52	VDDIO	Power	Power supply for differential outputs.
53	DIF12	Output	Differential true clock output.
54	DIF12#	Output	Differential complementary clock output.
55	DIF13	Output	Differential true clock output.
56	DIF13#	Output	Differential complementary clock output.
57	VDDIO	PWR	Power supply for differential outputs.
58	GND	GND	Ground pin.
59	DIF14	Output	Differential true clock output.
60	DIF14#	Output	Differential complementary clock output.
61	DIF15	Output	Differential true clock output.
62	DIF15#	Output	Differential complementary clock output.
63	GND	GND	Ground pin.
64	VDD	Power	Power supply, nominally 3.3V.
65	DIF16	Output	Differential true clock output.
66	DIF16#	Output	Differential complementary clock output.
67	DIF17	Output	Differential true clock output.
68	DIF17#	Output	Differential complementary clock output.
69	VDDIO	Power	Power supply for differential outputs.
70	GND	GND	Ground pin.

Table 1. Pin Descriptions (Cont.)

Number	Name	Type	Description
71	DIF18	Output	Differential true clock output.
72	DIF18#	Output	Differential complementary clock output.
73	EPAD	GND	Connect EPAD to ground.

Absolute Maximum Ratings

Stresses above the ratings listed below can cause permanent damage to the 9ZXL1930D / 9ZXL1950D. These ratings, which are standard values for IDT commercially rated parts, are stress ratings only. Functional operation of the device at these or any other conditions above those indicated in the operational sections of the specifications is not implied. Exposure to absolute maximum rating conditions for extended periods can affect product reliability. Electrical parameters are guaranteed only over the recommended operating temperature range.

Table 2. Absolute Maximum Ratings

Parameter	Symbol	Conditions	Minimum	Typical	Maximum	Units	Notes
Supply Voltage	V_{DDx}				3.9	V	1,2
Input Low Voltage	V_{IL}		GND - 0.5			V	1
Input Low Voltage	V_{IH}	Except for SMBus interface.			$V_{DD} + 0.5$	V	1,3
Input High Voltage, SMBus	V_{IHSMB}	SMBus clock and data pins.			3.9	V	1
Storage Temperature	T_s		-65		150	°C	1
Junction Temperature	T_j				125	°C	1
Input ESD Protection	ESD prot	Human Body Model.	2000			V	1

¹ Guaranteed by design and characterization, not 100% tested in production.

² Operation under these conditions is neither implied nor guaranteed.

³ Not to exceed 3.9V.

Electrical Characteristics

T_{AMB} = over the specified operating range. Supply voltages per normal operation conditions; see Test Loads for loading conditions.

Table 3. SMBus Parameters

Parameter	Symbol	Conditions	Minimum	Typical	Maximum	Units	Notes
SMBus Input Low Voltage	V_{ILSMB}				0.8	V	
SMBus Input High Voltage	V_{IHSMB}		2.1		V_{DDSMB}	V	
SMBus Output Low Voltage	V_{OLSMB}	At I_{PULLUP} .			0.4	V	
SMBus Sink Current	I_{PULLUP}	At V_{OL} .	4			mA	
Nominal Bus Voltage	V_{DDSMB}		2.7		3.6	V	1
SCLK/SDATA Rise Time	t_{RSMB}	(Max $V_{IL} - 0.15V$) to (Min $V_{IH} + 0.15V$).			1000	ns	1
SCLK/SDATA Fall Time	t_{FSMB}	(Min $V_{IH} + 0.15V$) to (Max $V_{IL} - 0.15V$).			300	ns	1
SMBus Operating Frequency	f_{SMBMAX}	Maximum SMBus operating frequency.			400	kHz	5

¹ Guaranteed by design and characterization, not 100% tested in production.

² Control input must be monotonic from 20% to 80% of input swing.

³ Time from deassertion until outputs are > 200mV.

⁴ DIF_IN input.

⁵ The differential input clock must be running for the SMBus to be active.

Table 4. DIF_IN Clock Input Parameters

Parameter	Symbol	Conditions	Minimum	Typical	Maximum	Units	Notes
Input Crossover Voltage – DIF_IN	V_{CROSS}	Cross over voltage.	150		900	mV	1
Input Swing – DIF_IN	V_{SWING}	Differential value.	300			mV	1
Input Slew Rate – DIF_IN	dv/dt	Measured differentially.	0.4		8	V/ns	1,2
Input Leakage Current	I_{IN}	$V_{IN} = V_{DD}$, $V_{IN} = GND$.	-5		5	μA	
Input Duty Cycle	d_{tin}	Measurement from differential waveform.	45		55	%	1
Input Jitter – Cycle to Cycle	J_{DIFIN}	Differential measurement.	0		125	ps	1

¹ Guaranteed by design and characterization, not 100% tested in production.

² Slew rate measured through $\pm 75mV$ window centered around differential zero.

Table 5. Input/Supply/Common Parameters

 T_{AMB} = over the specified operating range. Supply voltages per normal operation conditions; see Test Loads for loading conditions.

Parameter	Symbol	Conditions	Minimum	Typical	Maximum	Units	Notes
Supply Voltage	V_{DDx}	Supply voltage for core and analog.	3.135	3.3	3.465	V	
Output Supply Voltage	V_{DDIO}	Supply voltage for DIF outputs, if present.	0.95	1.05	3.465	V	
Ambient Operating Temperature	T_{AMB}	Industrial range (T_{IND}).	-40		85	°C	
Input High Voltage	V_{IH}	Single-ended inputs, except SMBus, tri-level inputs.	2		$V_{DD} + 0.3$	V	
Input Low Voltage	V_{IL}	Single-ended inputs, except SMBus, tri-level inputs.	GND - 0.3		0.8	V	
Input High Voltage	V_{IH}	Tri-level inputs (pins with 'tri' suffix).	2.2		$V_{DD} + 0.3$	V	
Input Mid Voltage	V_{IL}	Tri-level inputs (pins with 'tri' suffix).	1.2	$V_{DDx}/2$	1.8	V	
Input Low Voltage	V_{IL}	Tri-level inputs (pins with 'tri' suffix).	GND - 0.3		0.8	V	
Input Current	I_{IN}	Single-ended inputs, $V_{IN} = \text{GND}$, $V_{IN} = V_{DD}$.	-5		5	μA	
	I_{INP}	Single-ended inputs. $V_{IN} = 0\text{ V}$; inputs with internal pull-up resistors. $V_{IN} = V_{DD}$; inputs with internal pull-down resistors.	-50		50	μA	
Input Frequency	F_{ibyp}	Bypass Mode.	1		400	MHz	
	F_{ipll}	100MHz PLL Mode.	98	100.00	102	MHz	
	F_{ipll}	133.33MHz PLL Mode.	130	133.33	136	MHz	
Pin Inductance	L_{pin}				7	nH	1
Capacitance	C_{IN}	Logic inputs, except DIF_IN.	1.5		5	pF	1
	C_{INDIF_IN}	DIF_IN differential clock inputs.	1.5		2.7	pF	1,4
	C_{OUT}	Output pin capacitance.			6	pF	1
Clk Stabilization	T_{STAB}	From V_{DD} power-up and after input clock stabilization or deassertion of PD# to 1st clock.			1.8	ms	1,2
Input SS Modulation Frequency PCIe	$f_{MODINPCIe}$	Allowable frequency for PCIe applications (Triangular modulation).	30		33	kHz	
Tdrive_PD#	t_{DRVPD}	DIF output enable after PD# deassertion.			300	μs	1,3
Tfall	t_F	Fall time of control inputs.			5	ns	2
Trise	t_R	Rise time of control inputs.			5	ns	2

¹ Guaranteed by design and characterization, not 100% tested in production.

² Control input must be monotonic from 20% to 80% of input swing.

³ Time from deassertion until outputs are > 200mV.

⁴ DIF_IN input.

Table 6. Current Consumption

Parameter	Symbol	Conditions	Minimum	Typical	Maximum	Units	Notes
Operating Supply Current	I_{DDA+R}	$V_{DDA} + V_{DDR}$ pins, all outputs at 100MHz, $C_L = 2pF$; $Z_0 = 85\Omega$.		54	65	mA	
	I_{DDIO}	V_{DDIO} pins, all outputs at 100MHz, $C_L = 2pF$; $Z_0 = 85\Omega$.		136	169	mA	
	I_{DDx}	All other V_{DD} pins, all outputs at 100MHz, $C_L = 2pF$; $Z_0 = 85\Omega$.		28	38	mA	
Power Down Current	I_{DDA+R}	$V_{DDA} + V_{DDR}$ pins, all outputs Low/Low.		4	5	mA	
	I_{DDIO}	V_{DDIO} pins, all outputs Low/Low.		0.04	0.1	mA	
	I_{DDx}	All other V_{DD} pins, all outputs Low/Low.		0.4	1	mA	

Table 7. Skew and Differential Jitter Parameters

T_{AMB} = over the specified operating range. Supply voltages per normal operation conditions; see Test Loads for loading conditions.

Parameter	Symbol	Conditions	Minimum	Typical	Maximum	Units	Notes
CLK_IN, DIF[x:0]	t_{SPO_PLL}	Input-to-output skew in PLL Mode at 100MHz, nominal temperature and voltage.	-100	22	100	ps	1,2,4,5,8
CLK_IN, DIF[x:0]	t_{PD_BYP}	Input-to-output skew in Bypass Mode at 100MHz, nominal temperature and voltage.	2.2	2.9	3.5	ns	1,2,3,5,8
CLK_IN, DIF[x:0]	t_{DSPO_PLL}	Input-to-output skew variation in PLL Mode at 100MHz, across voltage and temperature.	-50	0	50	ps	1,2,3,5,8
CLK_IN, DIF[x:0]	t_{DSPO_BYP}	Input-to-output skew variation in Bypass Mode at 100MHz, across voltage and temperature.	-250		250	ps	1,2,3,5,8
		Input-to-output skew variation in Bypass Mode at 100MHz, across voltage and temperature, $T_{AMB} = T_{IND}$.	-350		350	ps	1,2,3,5,8
CLK_IN, DIF[x:0]	t_{DTE}	Random differential tracking error between two 9ZX devices in High BW Mode.			5	ps (rms)	1,2,3,5,8
CLK_IN, DIF[x:0]	t_{DSSTE}	Random differential spread spectrum tracking error between two 9ZX devices in High BW Mode.			40	ps	1,2,3,5,8
DIF[x:0]	t_{SKEW_ALL}	Output-to-output skew across all outputs, common to PLL and Bypass Mode, at 100MHz.		36	50	ps	1,2,3,8
PLL Jitter Peaking	$j_{peak-hibw}$	LOBW#_BYPASS_HIBW = 1.	0	1	2.5	dB	7,8
PLL Jitter Peaking	$j_{peak-lobw}$	LOBW#_BYPASS_HIBW = 0.	0	1	2	dB	7,8
PLL Bandwidth	pll_{HIBW}	LOBW#_BYPASS_HIBW = 1.	2	3	4	MHz	8,9
PLL Bandwidth	pll_{LOBW}	LOBW#_BYPASS_HIBW = 0.	0.7	1	1.4	MHz	8,9
Duty Cycle	t_{DC}	Measured differentially, PLL Mode.	45	50	55	%	1
Duty Cycle Distortion	t_{DCD}	Measured differentially, Bypass Mode at 100MHz.	-1	0	1	%	1,10
Jitter, Cycle to Cycle	$t_{j_{cyc-cyc}}$	PLL Mode.		20	50	ps	1,11
		Additive jitter in Bypass Mode.		3	10	ps	1,11

- ¹ Measured into fixed 2pF load cap. Input to output skew is measured at the first output edge following the corresponding input.
- ² Measured from differential cross-point to differential cross-point. This parameter can be tuned with external feedback path, if present.
- ³ All Bypass Mode input-to-output specs refer to the timing between an input edge and the specific output edge created by it.
- ⁴ This parameter is deterministic for a given device.
- ⁵ Measured with scope averaging on to find mean value.
- ⁶ “T” is the period of the input clock.
- ⁷ Measured as maximum pass band gain. At frequencies within the loop BW, highest point of magnification is called PLL jitter peaking.
- ⁸ Guaranteed by design and characterization, not 100% tested in production.
- ⁹ Measured at 3db down or half power point.
- ¹⁰ Duty cycle distortion is the difference in duty cycle between the output and the input clock when the device is operated in Bypass Mode.
- ¹¹ Measured from differential waveform.

Table 8. HCSSLP-HCSSL Outputs

T_{AMB} = over the specified operating range. Supply voltages per normal operation conditions; see Test Loads for loading conditions.

Parameter	Symbol	Conditions	Minimum	Typical	Maximum	Specification Limit	Units	Notes
Slew Rate	dV/dt	Scope averaging on.	2	2.6	4	1–4	V/ns	1,2,3
Slew Rate Matching	ΔdV/dt	Single-ended measurement.		7	19.7	20	%	1,4,7
Maximum Voltage	V _{max}	Measurement on single-ended signal using absolute value (scope averaging off).	660	815	888	1150	mV	7
Minimum Voltage	V _{min}		-117	-50		-300		7
Crossing Voltage (abs)	V _{cross_abs}	Scope averaging off.	250	399	550	250–550	mV	1,5,7
Crossing Voltage (var)	Δ-V _{cross}	Scope averaging off.		24	63	140	mV	1,6,7

- ¹ Guaranteed by design and characterization, not 100% tested in production.
- ² Measured from differential waveform.
- ³ Slew rate is measured through the V_{swing} voltage range centered around differential 0V. This results in a ±150mV window around differential 0V.
- ⁴ Matching applies to rising edge rate for Clock and falling edge rate for Clock#. It is measured using a ±75mV window centered on the average cross point where Clock rising meets Clock# falling. The median cross point is used to calculate the voltage thresholds the oscilloscope is to use for the edge rate calculations.
- ⁵ V_{cross} is defined as voltage where Clock = Clock# measured on a component test board and only applies to the differential rising edge (i.e. Clock rising and Clock# falling).
- ⁶ The total variation of all V_{cross} measurements in any particular system. Note that this is a subset of V_{cross_min/max} (V_{cross absolute}) allowed. The intent is to limit V_{cross} induced modulation by setting Δ-V_{cross} to be smaller than V_{cross absolute}.
- ⁷ At default SMBus settings.

Table 9. Filtered Phase Jitter Parameters – PCIe Common Clocked (CC) Architectures

Parameter	Symbol	Conditions	Minimum	Typical	Maximum	Specification Limit	Units	Notes
Phase Jitter, PLL Mode	$t_{jphPCIeG1-CC}$	PCIe Gen1.		13	34	86	ps (p-p)	1,2,3
	$t_{jphPCIeG2-CC}$	PCIe Gen2 Low Band 10kHz < f < 1.5MHz (PLL BW of 5–16MHz or 8–16MHz, CDR = 5MHz).		0.2	0.63	3	ps (rms)	1,2
		PCIe Gen2 High Band 1.5MHz < f < Nyquist (50MHz) (PLL BW of 5–16MHz or 8–16MHz, CDR = 5MHz).		1.0	1.47	3.1	ps (rms)	1,2
	$t_{jphPCIeG3-CC}$	PCIe Gen3 (PLL BW of 2–4MHz or 2–5MHz, CDR = 10MHz).		0.2	0.34	1	ps (rms)	1,2
	$t_{jphPCIeG4-CC}$	PCIe Gen4 (PLL BW of 2–4MHz or 2–5MHz, CDR = 10MHz).		0.2	0.34	0.5	ps (rms)	1,2
Additive Phase Jitter, Bypass Mode	$t_{jphPCIeG1-CC}$	PCIe Gen1.		0.01	0.052	Not Applicable	ps (p-p)	1,2,3,4
	$t_{jphPCIeG2-CC}$	PCIe Gen2 Low Band 10kHz < f < 1.5MHz (PLL BW of 5–16MHz or 8–16MHz, CDR = 5MHz).		0.01	0.052		ps (rms)	1,2,3,4
		PCIe Gen2 High Band 1.5MHz < f < Nyquist (50MHz) (PLL BW of 5–16MHz or 8–16MHz, CDR = 5MHz).		0.0	0.052		ps (rms)	1,2,3,4
	$t_{jphPCIeG3-CC}$	PCIe Gen3 (PLL BW of 2–4MHz or 2–5MHz, CDR = 10MHz).		0.01	0.052		ps (rms)	1,2,3,4
	$t_{jphPCIeG4-CC}$	PCIe Gen4 (PLL BW of 2–4MHz or 2–5MHz, CDR = 10MHz).		0.01	0.052		ps (rms)	1,2,3,4

Table 10. Filtered Phase Jitter Parameters – PCIe Independent Reference (IR) Architectures

Parameter	Symbol	Conditions	Minimum	Typical	Maximum	Specification Limits	Units	Notes
Phase Jitter, PLL Mode	$t_{jphPCleG2-SRIS}$	PCIe Gen 2 (PLL BW of 16MHz, CDR = 5MHz).		0.9	1.05	2	ps (rms)	1,2,5
	$t_{jphPCleG3-SRIS}$	PCIe Gen 3 (PLL BW of 2–4MHz, CDR = 10MHz).		0.6	0.68	0.7	ps (rms)	1,2,5
Additive Phase Jitter, Bypass Mode	$t_{jphPCleG2-SRIS}$	PCIe Gen 2 (PLL BW of 16MHz, CDR = 5MHz).		0.01	0.042	Not applicable	ps (rms)	1,2,4,5
	$t_{jphPCleG3-SRIS}$	PCIe Gen 3 (PLL BW of 2–4MHz, CDR = 10MHz).		0.01	0.042		ps (rms)	1,2,4,5

Notes for PCIe Filtered Phase Jitter tables (CC) and (IR).

- ¹ Applies to all differential outputs, guaranteed by design and characterization.
- ² Calculated from Intel™-supplied clock jitter tool when driven by 9SQL495x or equivalent with spread on and off.
- ³ Sample size of at least 100K cycles. This figure extrapolates to 108ps pk-pk at 1M cycles for a BER of 1^{-12} .
- ⁴ For RMS values, additive jitter is calculated by solving for b [$b = \sqrt{c^2 - a^2}$] where “a” is rms input jitter and “c” is rms total jitter.
- ⁵ IR is the new name for Separate Reference Independent Spread (SRIS) and Separate Reference no Spread (SRNS) PCIe clock architectures. According to the PCIe Base Specification Rev4.0 version 0.7 draft, the jitter transfer functions and corresponding jitter limits are not defined for the IR clock architecture. Widely accepted industry limits using widely accepted industry filters are used to populate this table. There are no accepted filters or limits for IR clock architectures at PCIe Gen1 or Gen4 data rates.

Table 11. Filtered Phase Jitter Parameters – QPI/UPI

Parameter	Symbol	Conditions	Minimum	Typical	Maximum	Specification Limit	Units	Notes
Phase Jitter, PLL Mode	t_{jphQPI_UPI}	QPI & UPI (100MHz or 133MHz, 4.8Gb/s, 6.4Gb/s 12UI).		0.14	0.25	0.5	ps (rms)	1,2
		QPI & UPI (100MHz, 8.0Gb/s, 12UI).		0.07	0.09	0.3		1,2
		QPI & UPI (100MHz, ≥ 9.6 Gb/s, 12UI).		0.06	0.074	0.2		1,2
	t_{jphIF_UPI}	IF-UPI.		0.1 0.17	0.14 0.2	1		1,4,5
Additive Phase Jitter, Bypass Mode	t_{jphQPI_UPI}	QPI & UPI (100MHz or 133MHz, 4.8Gb/s, 6.4Gb/s 12UI).		0.00	0.01	Not applicable	ps (rms)	1,2,3
		QPI & UPI (100MHz, 8.0Gb/s, 12UI).		0.00	0.01			1,2,3
		QPI & UPI (100MHz, ≥ 9.6 Gb/s, 12UI).		0.00	0.01			1,2,3
	t_{jphIF_UPI}	IF-UPI.		0.06	0.07			1,4

- ¹ Applies to all differential outputs, guaranteed by design and characterization.
- ² Calculated from Intel-supplied clock jitter tool, when driven by 9SQL495x or equivalent with spread on and off.
- ³ For RMS values, additive jitter is calculated by solving for b [$b = \sqrt{c^2 - a^2}$] where “a” is rms input jitter and “c” is rms total jitter.
- ⁴ Calculated from phase noise analyzer when driven by Wenzel Associates source with Intel-specified brick-wall filter applied.
- ⁵ Top number is when the buffer is in Low BW mode; bottom number is when the buffer is in High BW mode.

Table 12. Filtered Phase Jitter Parameters – DB2000Q Filter

Parameter	Symbol	Conditions	Minimum	Typical	Maximum	Specification Limit	Units	Notes
Additive Phase Jitter	$t_{jph12k-20Madd}$	100MHz		50		80	fs (rms)	1,2

¹ Applies to all outputs when driven by Wenzel Associates source.

² For RMS values, additive jitter is calculated by solving for b [$b = \sqrt{c^2 - a^2}$] where “a” is rms input jitter and “c” is rms total jitter.

Table 13. Unfiltered Phase Jitter Parameters – 12kHz to 20MHz

Parameter	Symbol	Conditions	Minimum	Typical	Maximum	Specification Limit	Units	Notes
Phase Jitter, PLL Mode	$t_{jph12k-20MHi}$	PLL High BW, SSC Off, 100MHz		194	233	Not applicable	fs (rms)	1,2
Phase Jitter, PLL Mode	$t_{jph12k-20MLo}$	PLL Low BW, SSC Off, 100MHz		212	248		fs (rms)	1,2
Additive Phase Jitter, Bypass Mode	$t_{jph12k-20MBy}$	Bypass Mode, SSC Off, 100MHz		105	124		fs (rms)	1,2,3

¹ Applies to all outputs when driven by Wenzel Associates source.

² 12kHz to 20MHz brick wall filter.

³ For RMS values, additive jitter is calculated by solving for b [$b = \sqrt{c^2 - a^2}$] where “a” is rms input jitter and “c” is rms total jitter.

Clock Periods

Table 14. Clock Periods – Differential Outputs with Spread Spectrum Disabled

SSC On	Center Frequency MHz	Measurement Window							Units	Notes
		1 Clock	1µs	0.1s	0.1s	0.1s	1µs	1 Clock		
		-c2cjitter AbsPer Minimum	-SSC Short-Term Average Minimum	-ppm Long-Term Average Minimum	0 ppm Period Nominal	+ppm Long-Term Average Maximum	+SSC Short-Term Average Maximum	+c2cjitter AbsPer Maximum		
DIF	100.00	9.94900	—	9.99900	10.00000	10.00100	—	10.05100	ns	1,2,3
	133.33	7.44925	—	7.49925	7.50000	7.50075	—	7.55075	ns	1,2,4

Table 15. Clock Periods – Differential Outputs with Spread Spectrum Enabled

SSC On	Center Frequency MHz	Measurement Window							Units	Notes
		1 Clock	1µs	0.1s	0.1s	0.1s	1µs	1 Clock		
		-c2cjitter AbsPer Minimum	-SSC Short-Term Average Minimum	-ppm Long-Term Average Minimum	0 ppm Period Nominal	+ppm Long-Term Average Maximum	+SSC Short-Term Average Maximum	+c2cjitter AbsPer Maximum		
DIF	99.75	9.94906	9.99906	10.02406	10.02506	10.02607	10.05107	10.10107	ns	1,2,3
	133.00	7.44930	7.49930	7.51805	7.51880	7.51955	7.53830	7.58830	ns	1,2,4

¹ Guaranteed by design and characterization, not 100% tested in production.

² All Long Term Accuracy specifications are guaranteed with the assumption that the input clock complies with CK420BQ accuracy requirements (± 100 ppm). The buffer itself does not contribute to ppm error.

³ Driven by SRC output of main clock, 100MHz PLL Mode or Bypass Mode.

⁴ Driven by CPU output of main clock, 133MHz PLL Mode or Bypass Mode.

Power Management

Inputs		Control Bits	Outputs		PLL State
CKPWRGD_PD#	DIF_IN/DIF_IN#	SMBus EN bit	DIFx/DIFx#	FBOUT_NC/FBOUT_NC#	
0	X	X	Low/Low	Low/Low	Off
1	Running	0	Low/Low	Running	On
		1	Running	Running	On

Power Connections

Pin Number			Description
V _{DD}	V _{DDIO}	GND	
1		2	Analog PLL
7		6	Analog input
28, 45, 64	21, 33, 40, 52, 57, 69	16, 22, 27, 34, 39, 46, 51, 58, 63, 70, 73	DIF clocks

Functionality at Power-Up (PLL Mode)

100M_133M#	Input (MHz)	Output (MHz)
1	100.00	100.00
0	133.33	133.33

PLL Operating Mode

HIBW_BYPM_LOBW#	Byte 0, bit [7:6]
Low (PLL Low BW)	00
Mid (Bypass)	01
High (PLL High BW)	11

SMBus Addressing

SADR[1:0]_tri	SMBus Address (Read/Write bit = 0)
00	D8
0M	DA
01	DE
M0	C2
MM	C4
M1	C6
10	CA
1M	CC
11	CE

Test Loads

Low-Power HCSL Output Test Load
(standard PCIe source-terminated test load)

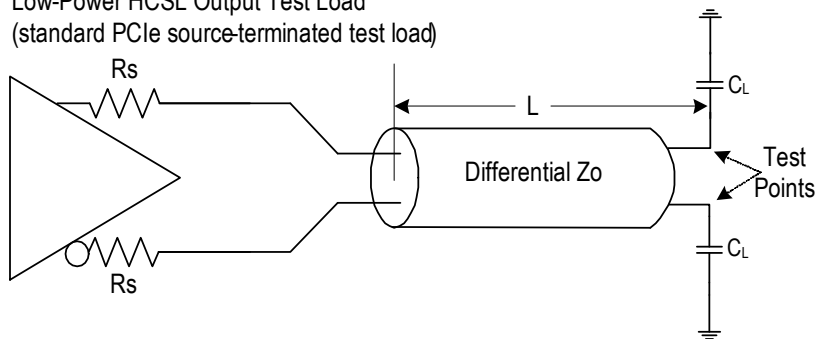

Table 16. Parameters for Low-Power HCSL Output Test Load

Device	Rs (Ω)	Zo (Ω)	L (inches)	CL (pF)
9ZXL1930	27	85	10	2
	33	100	10	2
9ZXL1950*	Internal	85	10	2
	7.5	100	10	2

* Contact factory for versions of this device with Zo = 100 Ω .

Alternate Terminations

The LP-HCSL output can easily drive other logic families. See [“AN-891 Driving LVPECL, LVDS, and CML Logic with IDT’s “Universal” Low-Power HCSL Outputs”](#) for termination schemes for LVPECL, LVDS, CML and SSTL.

General SMBus Serial Interface Information

How to Write

- Controller (host) sends a start bit
- Controller (host) sends the write address
- IDT clock will **acknowledge**
- Controller (host) sends the beginning byte location = N
- IDT clock will **acknowledge**
- Controller (host) sends the byte count = X
- IDT clock will **acknowledge**
- Controller (host) starts sending **Byte N–Byte N+X-1**
- IDT clock will **acknowledge** each byte **one at a time**
- Controller (host) sends a stop bit

Index Block Write Operation				
Controller (Host)		X Byte	IDT (Slave/Receiver)	
T	starT bit			
Slave Address				
WR	WRite			
				ACK
Beginning Byte = N				
				ACK
Data Byte Count = X				
				ACK
Beginning Byte N				
				ACK
O				O
O				O
O			O	
			O	
Byte N + X - 1				
			ACK	
P	stoP bit			

How to Read

- Controller (host) will send a start bit
- Controller (host) sends the write address
- IDT clock will **acknowledge**
- Controller (host) sends the beginning byte location = N
- IDT clock will **acknowledge**
- Controller (host) will send a separate start bit
- Controller (host) sends the read address
- IDT clock will **acknowledge**
- IDT clock will send the data byte count = X
- IDT clock sends **Byte N+X-1**
- IDT clock sends **Byte 0–Byte X (if X_(H) was written to Byte 8)**
- Controller (host) will need to acknowledge each byte
- Controller (host) will send a not acknowledge bit
- Controller (host) will send a stop bit

Index Block Read Operation				
Controller (Host)		X Byte	IDT (Slave/Receiver)	
T	starT bit			
Slave Address				
WR	WRite			
				ACK
Beginning Byte = N				
				ACK
RT	Repeat starT			
Slave Address				
RD	ReaD			
				ACK
				Data Byte Count=X
			ACK	
			Beginning Byte N	
			O	
			O	
			O	
			Byte N + X - 1	
N	Not			
P	stoP bit			

SMBus Table: PLL Mode and Frequency Select Register

Byte 0	Pin #	Name	Control Function	Type	0	1	Default
Bit 7	—	PLL Mode 1	PLL Operating Mode Readback 1	R	See <i>PLL Operating Mode</i> table		Latch
Bit 6	—	PLL Mode 0	PLL Operating Mode Readback 0	R			Latch
Bit 5	—	DIF_18_En	Output Control	RW	Disable (Low/Low)	Enable	1
Bit 4	—	DIF_17_En	Output Control	RW			1
Bit 3	—	DIF_16_En	Output Control	RW			1
Bit 2	Reserved						0
Bit 1	Reserved						0
Bit 0	—	100M_133M#	Frequency Select Readback	R	133MHz	100MHz	Latch

SMBus Table: Output Control Register

Byte 1	Pin #	Name	Control Function	Type	0	1	Default
Bit 7	—	DIF_7_En	Output Enable	RW	Disable (Low/Low)	Enable	1
Bit 6	—	DIF_6_En	Output Enable	RW			1
Bit 5	—	DIF_5_En	Output Enable	RW			1
Bit 4	—	DIF_4_En	Output Enable	RW			1
Bit 3	—	DIF_3_En	Output Enable	RW			1
Bit 2	—	DIF_2_En	Output Enable	RW			1
Bit 1	—	DIF_1_En	Output Enable	RW			1
Bit 0	—	DIF_0_En	Output Enable	RW			1

SMBus Table: Output Control Register

Byte 2	Pin #	Name	Control Function	Type	0	1	Default
Bit 7	—	DIF_15_En	Output Control	RW	Disable (Low/Low)	Enable	1
Bit 6	—	DIF_14_En	Output Control	RW			1
Bit 5	—	DIF_13_En	Output Control	RW			1
Bit 4	—	DIF_12_En	Output Control	RW			1
Bit 3	—	DIF_11_En	Output Enable	RW			1
Bit 2	—	DIF_10_En	Output Enable	RW			1
Bit 1	—	DIF_9_En	Output Enable	RW			1
Bit 0	—	DIF_8_En	Output Enable	RW			1

SMBus Table: Reserved Register

Byte 3	Pin #	Name	Control Function	Type	0	1	Default
Bit 7	—	amp[2]	Global Differential Output Control (LP-HCSL Outputs Only)	RW	0.3V–1V 100mV/step Default = 0.8V		1
Bit 6	—	amp[1]		RW			0
Bit 5	—	amp[0]		RW			1
Bit 4	Reserved						0
Bit 3	—	PLL_SW_EN	Enable S/W Control of PLL BW	RW	Hardware Latch	SMBus Control	0
Bit 2	—	PLL Mode 1	PLL Operating Mode 1	RW	See <i>PLL Operating Mode</i> table		Latch
Bit 1	—	PLL Mode 0	PLL Operating Mode 1	RW			Latch
Bit 0	Reserved						0

Note: Setting bit 3 to '1' allows the user to override the latch value from pin 4 via use of bits 2 and 1. Use the values from the *PLL Operating Mode* table. Note that Byte 0, bits 7:6 will keep the value originally latched on pin 4. If the user changes these bits, a warm reset of the system will have to be accomplished.

SMBus Table: Reserved Register

Byte 4	Pin #	Name	Control Function	Type	0	1	Default
Bit 7	Reserved						0
Bit 6	Reserved						0
Bit 5	Reserved						0
Bit 4	Reserved						0
Bit 3	Reserved						0
Bit 2	Reserved						0
Bit 1	Reserved						0
Bit 0	Reserved						0

SMBus Table: Vendor & Revision ID Register

Byte 5	Pin #	Name	Control Function	Type	0	1	Default
Bit 7	—	RID3	REVISION ID	R	D = 0011		0
Bit 6	—	RID2		R			0
Bit 5	—	RID1		R			1
Bit 4	—	RID0		R			1
Bit 3	—	VID3	VENDOR ID	R	ICS/IDT = 0001		0
Bit 2	—	VID2		R			0
Bit 1	—	VID1		R			0
Bit 0	—	VID0		R			1

SMBus Table: Device ID

Byte 6	Pin #	Name	Control Function	Type	0	1	Default
Bit 7	—	Device ID 7 (MSB)		R	1930/1950 = 195 Decimal or C3 Hex		1
Bit 6	—	Device ID 6		R			x
Bit 5	—	Device ID 5		R			0
Bit 4	—	Device ID 4		R			x
Bit 3	—	Device ID 3		R			x
Bit 2	—	Device ID 2		R			0
Bit 1	—	Device ID 1		R			1
Bit 0	—	Device ID 0		R			1

SMBus Table: Byte Count Register

Byte 7	Pin #	Name	Control Function	Type	0	1	Default
Bit 7	Reserved						0
Bit 6	Reserved						0
Bit 5	Reserved						0
Bit 4	—	BC4	Writing to this register configures how many bytes will be read back.	RW	Default value is 8 hex, so 9 bytes (0 to 8) will be read back by default.		0
Bit 3	—	BC3		RW			1
Bit 2	—	BC2		RW			0
Bit 1	—	BC1		RW			0
Bit 0	—	BC0		RW			0

Package Outline Drawings

The package outline drawings are appended at the end of this document and are accessible from the link below. The package information is the most current data available.

www.idt.com/document/psc/nlnlg72-package-outline-100-x-100-mm-body-epad-59-mm-sq-050-mm-pitch-vfqfpn-sawn

Ordering Information

Orderable Part Number	Differential Output Impedance (Ω)	Package	Carrier Type	Temperature
9ZXL1930DKILF	33	10 x 10 mm, 0.50mm pitch 72-VFQFPN	Trays	-40°C to +85°C
9ZXL1930DKILFT	33	10 x 10 mm, 0.50mm pitch 72-VFQFPN	Reel	-40°C to +85°C
9ZXL1950DKILF	85	10 x 10 mm, 0.50mm pitch 72-VFQFPN	Trays	-40°C to +85°C
9ZXL1950DKILFT	85	10 x 10 mm, 0.50mm pitch 72-VFQFPN	Reel	-40°C to +85°C

“LF” designates PB-free configuration, RoHS compliant.

“D” is the device revision designator (will not correlate with the datasheet revision).

Marking Diagrams

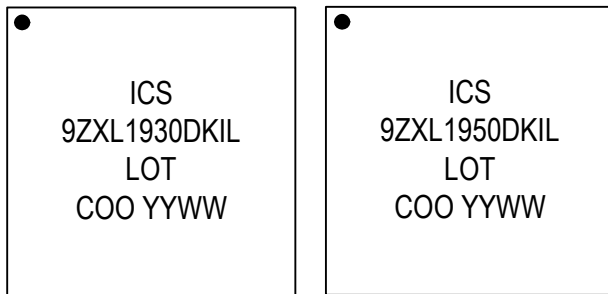

1. "I" denotes industrial temperature range
2. "L" denotes RoHS compliant package.
3. "YYWW" denotes the last two digits of the year and week the part was assembled.
4. "COO" denotes country of origin.
5. "LOT" denotes the lot number.

Revision History

Revision Date	Description of Change
April 13, 2018	Updated absolute maximum supply voltage rating and VIHSMB to 3.9V.
February 13, 2018	<ul style="list-style-type: none"> ▪ Updated front page text to indicate DB2000Q compatibility. ▪ Removed reference to 5V tolerance in description of SMBDAT and SMBCLK pins. ▪ Added DB2000Q additive phase jitter table.
December 1, 2017	Removed "5V tolerant" reference in pins 11 and 12 descriptions.
November 2, 2017	<ul style="list-style-type: none"> ▪ Corrected PCIe, UPI phase jitter tables per characterization data. ▪ Corrected transposed values for HiBW and Bypass Mode unfiltered phase jitter.
September 29, 2017	Initial release.



Corporate Headquarters
 6024 Silver Creek Valley Road
 San Jose, CA 95138 USA
www.IDT.com

Sales
 1-800-345-7015 or 408-284-8200
 Fax: 408-284-2775
www.IDT.com/go/sales

Tech Support
www.IDT.com/go/support

DISCLAIMER Integrated Device Technology, Inc. (IDT) and its affiliated companies (herein referred to as "IDT") reserve the right to modify the products and/or specifications described herein at any time, without notice, at IDT's sole discretion. Performance specifications and operating parameters of the described products are determined in an independent state and are not guaranteed to perform the same way when installed in customer products. The information contained herein is provided without representation or warranty of any kind, whether express or implied, including, but not limited to, the suitability of IDT's products for any particular purpose, an implied warranty of merchantability, or non-infringement of the intellectual property rights of others. This document is presented only as a guide and does not convey any license under intellectual property rights of IDT or any third parties.

IDT's products are not intended for use in applications involving extreme environmental conditions or in life support systems or similar devices where the failure or malfunction of an IDT product can be reasonably expected to significantly affect the health or safety of users. Anyone using an IDT product in such a manner does so at their own risk, absent an express, written agreement by IDT.

Integrated Device Technology, IDT and the IDT logo are trademarks or registered trademarks of IDT and its subsidiaries in the United States and other countries. Other trademarks used herein are the property of IDT or their respective third party owners. For datasheet type definitions and a glossary of common terms, visit www.idt.com/go/glossary. Integrated Device Technology, Inc All rights reserved.

DATE		REVISIONS		AUTHOR
CREATED	REV	DESCRIPTION		
2/2/16	00	INITIAL RELEASE.		JH
1/11/17	01	CORRECT <i>eee</i> TOLERANCE.		JH
5/8/17	02	CHANGE PACKAGE CODE QFN to VFQFPN		JH

NOTE: REFER TO DCP FOR OFFICIAL RELEASE DATE

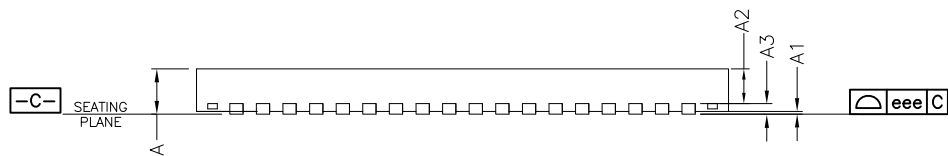
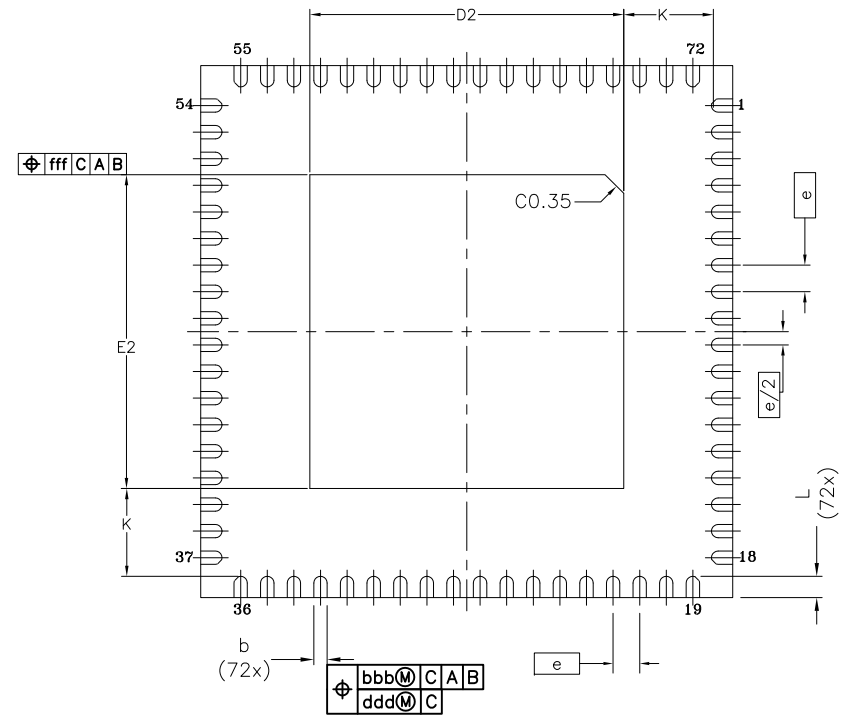
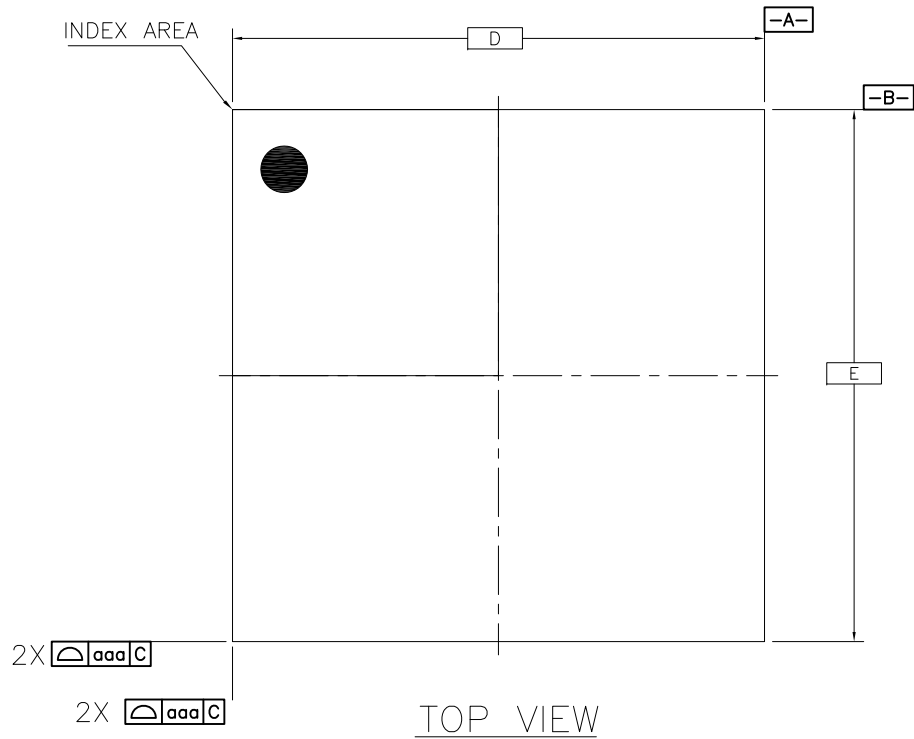

NOTES:

1. ALL DIMENSIONING AND TOLERANCING CONFORM TO ANSI Y14.5M-1994
2. ALL DIMENSIONS ARE IN MILLIMETERS.
3. INDEX AREA (PIN1 IDENTIFIER)

TOLERANCES
UNLESS SPECIFIED
DECIMAL ANGULAR
X±
XX±
XXX±



6024 Silver Creek Valley Road
San Jose, CA 95138
PHONE: (408) 284-8200
FAX: (408) 284-8591

TITLE NL/NLG72 PACKAGE OUTLINE
10.0 x 10.0 mm BODY, EPAD 5.9mm SQ.
0.50 mm Pitch VFQFPN (SAWN)

SIZE	DRAWING No.	REV
C	PSC-4208-01	02

DO NOT SCALE DRAWING

SHEET 1 OF 3

DATE		REVISIONS	
CREATED	REV	DESCRIPTION	AUTHOR
2/2/16	00	INITIAL RELEASE.	JH
1/11/17	01	CORRECT eee TOLERANCE.	JH
5/8/17	02	CHANGE PACKAGE CODE QFN to VFQFPN	JH

NOTE: REFER TO DCP FOR OFFICIAL RELEASE DATE

SYMBOL	DIMENSIONS		
	MIN.	NOM.	MAX.
D2	5.80	5.90	6.00
E2	5.80	5.90	6.00
A2	0.00	0.65	1.00
L	0.30	0.40	0.50
A	0.80	0.90	1.00
A1	0.00	0.02	0.05
A3	0.20 ref.		
b	0.18	0.25	0.30
Ⓢ	0.50 BSC		
D	10.00 BSC		
E	10.00 BSC		
K	1.65 ref.		
TOLERANCES			
aaa	0.15		
bbb	0.10		
ccc	0.05		
eee	0.08		
fff	0.10		

TOLERANCES UNLESS SPECIFIED		 IDT™ www.IDT.com	6024 Silver Creek Valley Road San Jose, CA 95138 PHONE: (408) 284-8200 FAX: (408) 284-8591
DECIMAL	ANGULAR		
X±		TITLE NL/NLG72 PACKAGE OUTLINE 10.0 x 10.0 mm BODY, EPAD 5.9mm SQ. 0.50 mm Pitch VFQFPN (SAWN)	
XX±		SIZE	DRAWING No.
XXX±		C	PSC-4208-01
			REV 02
DO NOT SCALE DRAWING			SHEET 2 OF 3

DATE		REVISIONS	
CREATED	REV	DESCRIPTION	AUTHOR
2/2/16	00	INITIAL RELEASE.	JH
1/11/17	01	CORRECT eee TOLERANCE.	JH
5/8/17	02	CHANGE PACKAGE CODE QFN to VFQFPN	JH
NOTE: REFER TO DCP FOR OFFICIAL RELEASE DATE			

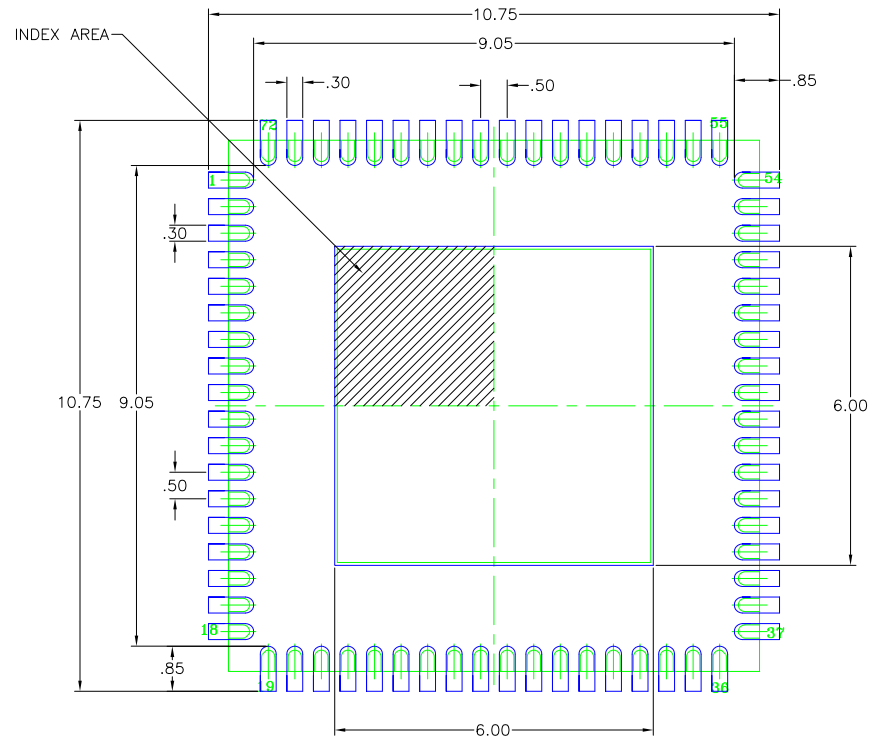

RECOMMENDED LAND PATTERN DIMENSION

NOTES:

1. ALL DIMENSIONS ARE IN mm. ANGLES IN DEGREES.
2. TOP DOWN VIEW. AS VIEWED ON PCB.
3. COMPONENT OUTLINE SHOWS FOR REFERENCE IN GREEN.
4. LAND PATTERN IN BLUE. NSMD PATTERN ASSUMED.
5. LAND PATTERN RECOMMENDATION PER IPC-7351B GENERIC REQUIREMENT FOR SURFACE MOUNT DESIGN AND LAND PATTERN.

TOLERANCES
UNLESS SPECIFIED
DECIMAL ANGULAR
X±
XX±
XXX±



6024 Silver Creek Valley Road
San Jose, CA 95138
PHONE: (408) 284-8200
FAX: (408) 284-8591

TITLE NL/NLG72 PACKAGE OUTLINE
10.0 x 10.0 mm BODY, EPAD 5.9mm SQ.
0.50 mm Pitch VFQFPN (SAWN)

SIZE	DRAWING No.	REV
C	PSC-4208-01	02

DO NOT SCALE DRAWING

SHEET 3 OF 3