

F1200 Temperature Performance

- August 10, 2014
- AT0089

- Revised September 3, 2014

Michael J. Virostko
Principal Product Application Engineer



The Analog and Digital Company™



Agenda

- Introduction
- Testing
- Results



Introduction

- Customer is interested in the F1200, Intermediate Frequency Digital Variable Gain Amplifier, and has a concern with temperature variation.
- The temperature specification say the product can be used to +85 °C. Customer's environment can go to +105 °C.
- Customer is interested in the parameter variations with the temperature.



S-Parameter Test Setup

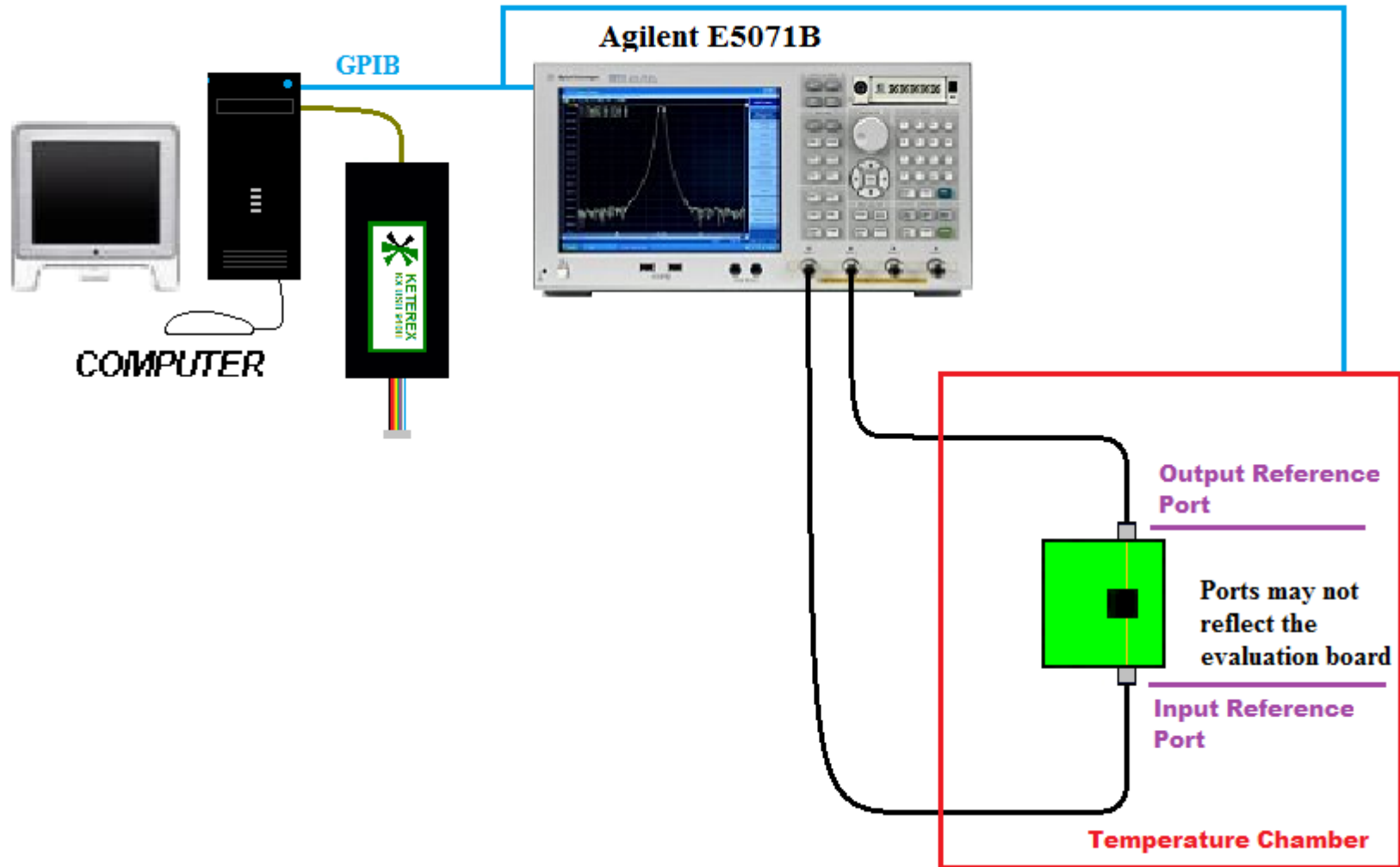

Maximum Gain Variation

F1200 (Evaluation Board) - EB4313002
Maximum Gain

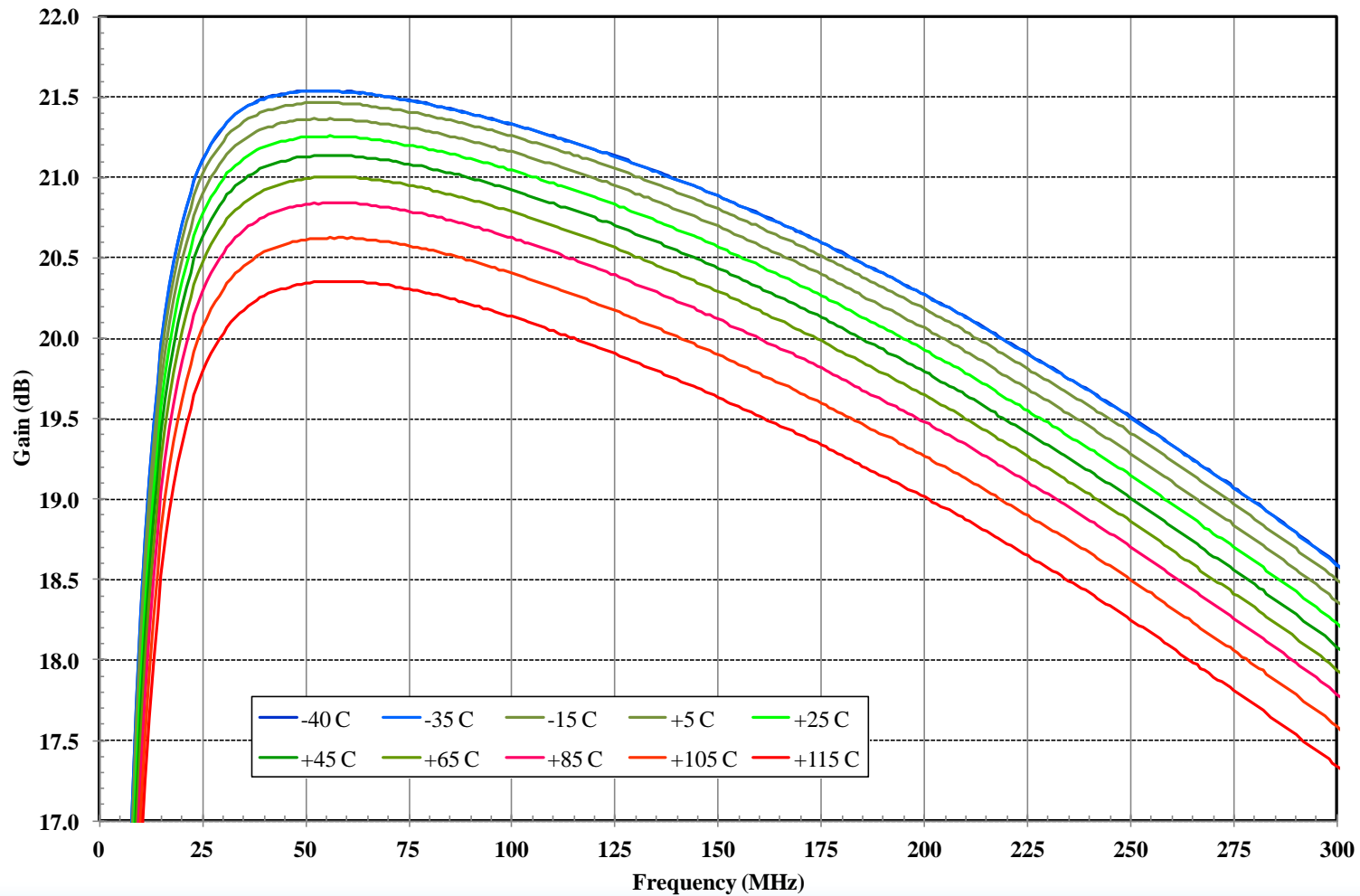

Attenuator Accuracy at 50 MHz

F1200 (Evaluation Board) - EB4313002
Bit Error - 50 MHz

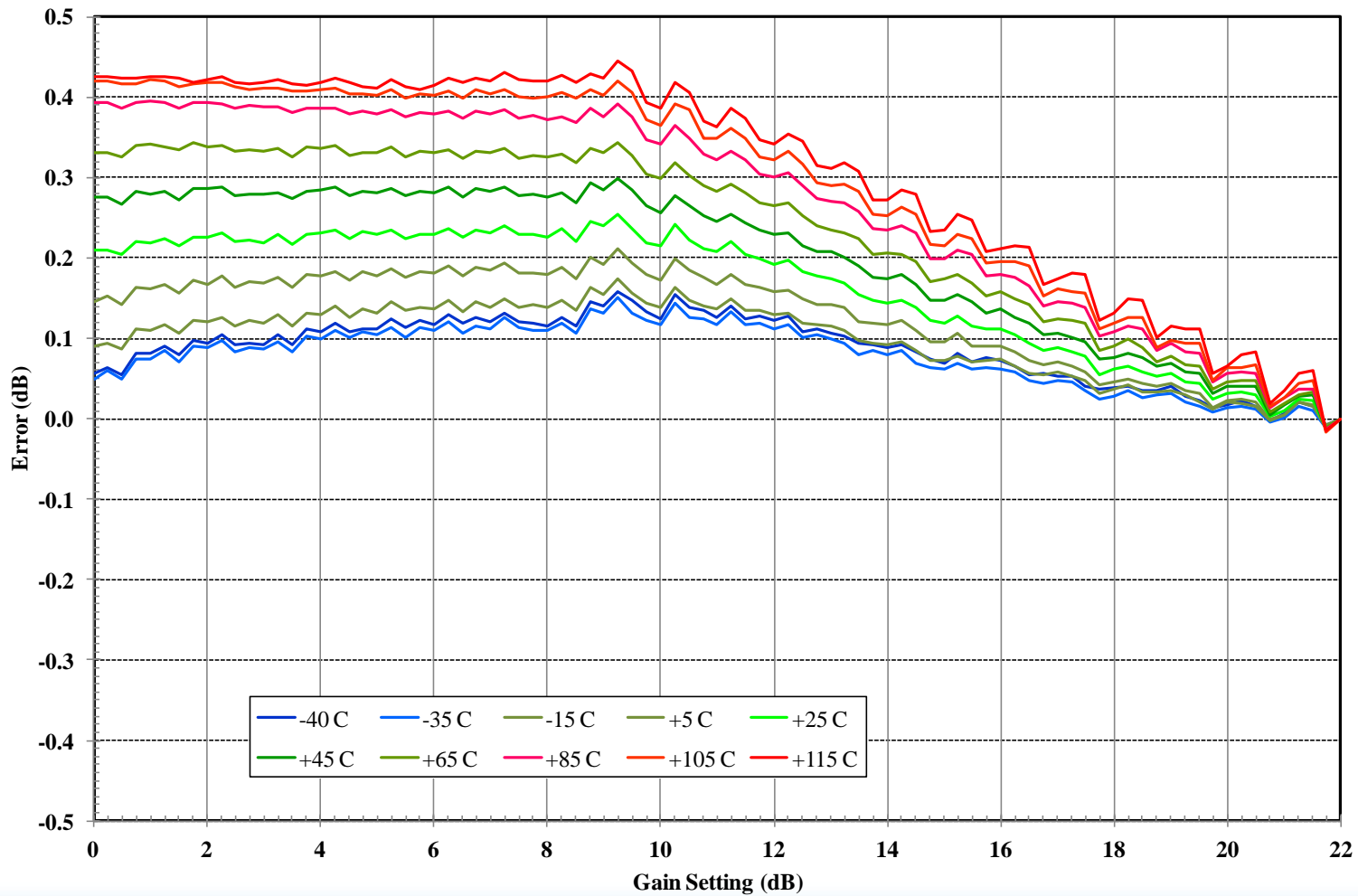

Attenuator Accuracy at 100 MHz

F1200 (Evaluation Board) - EB4313002
Bit Error - 100 MHz

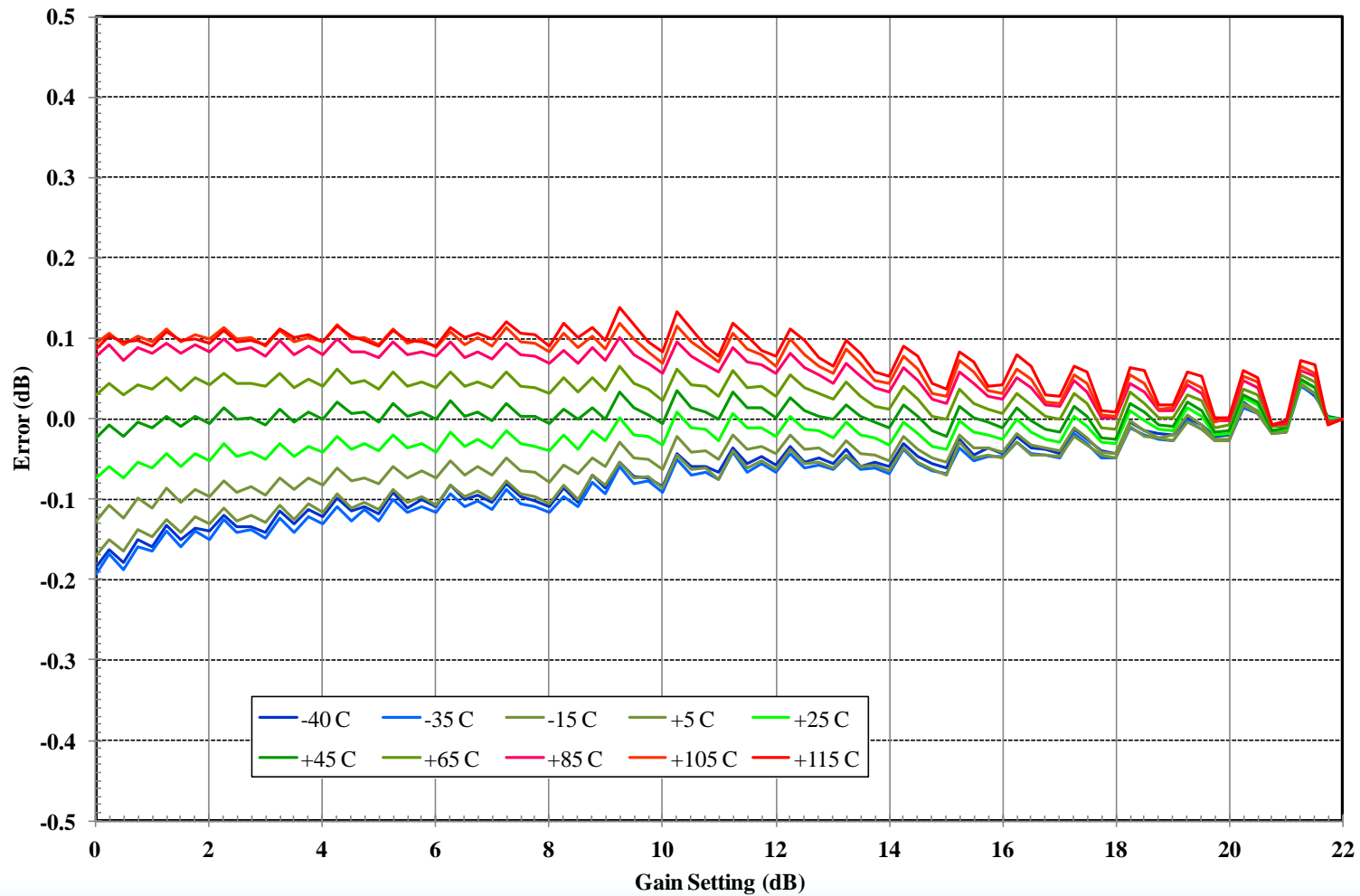

Attenuator Accuracy at 160 MHz

F1200 (Evaluation Board) - EB4313002
Bit Error - 160 MHz

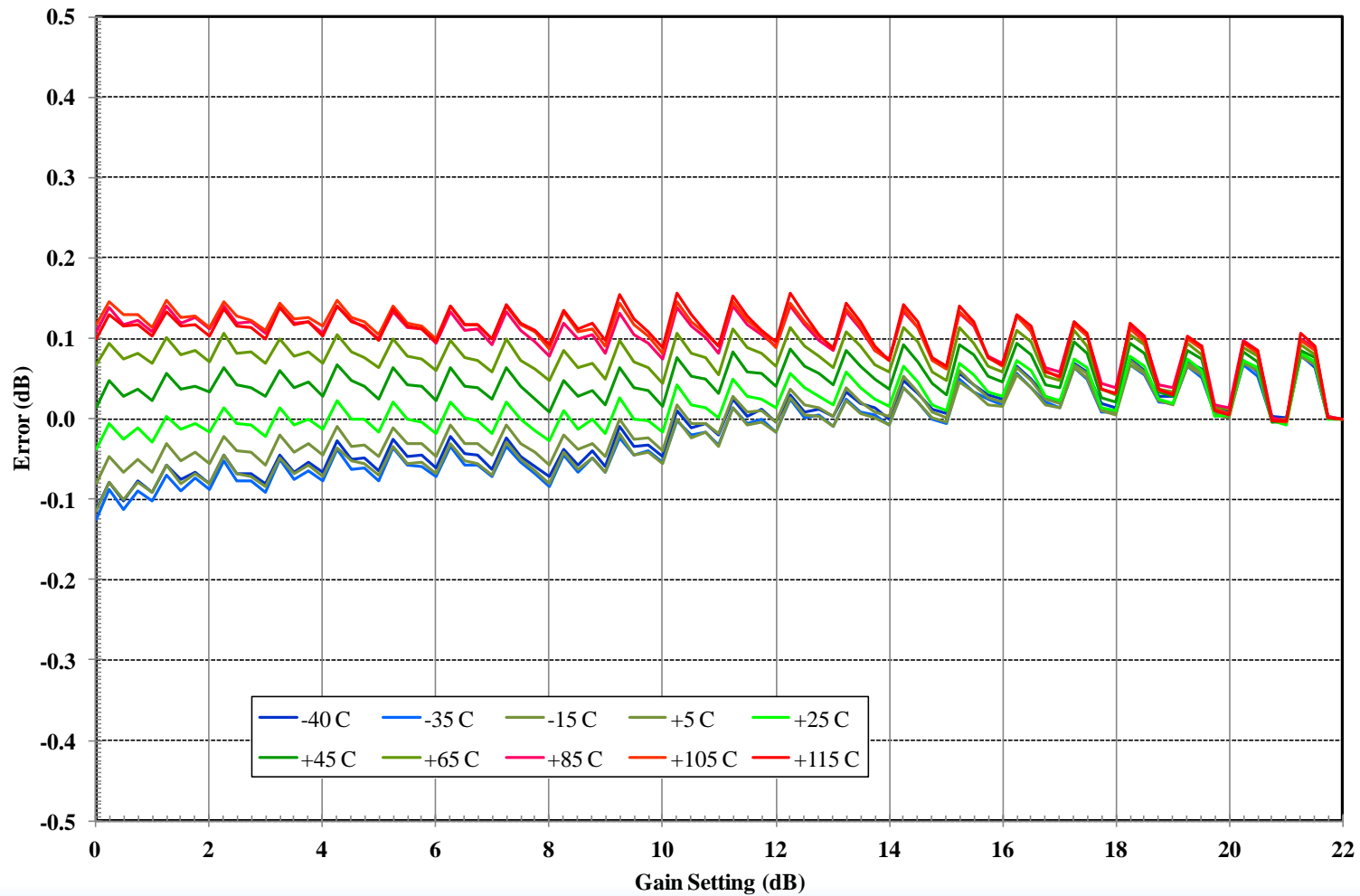

Step Accuracy (DNL) at 50 MHz

F1200 (Evaluation Board) - EB4313002
Step Error - 50 MHz

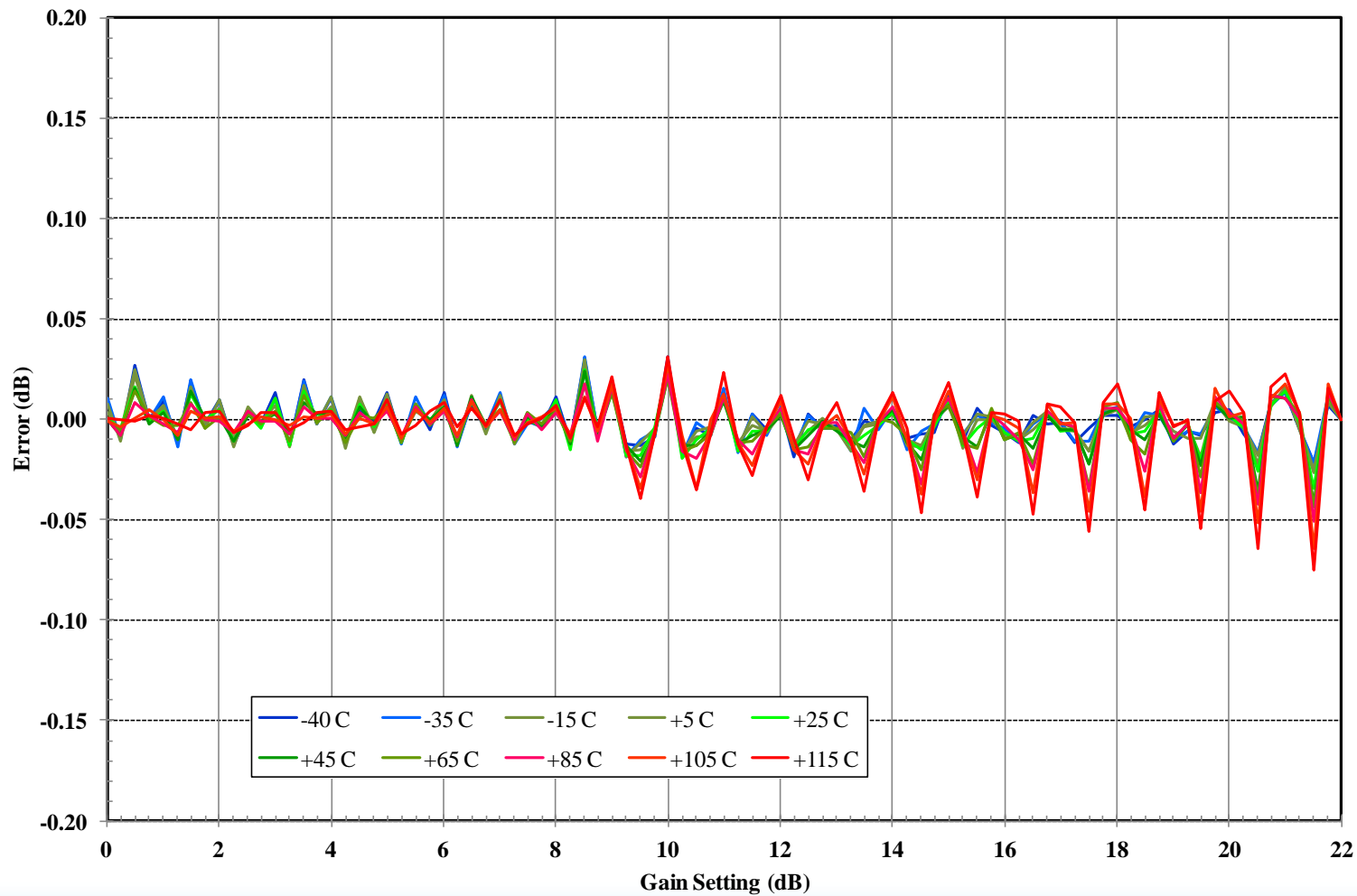

Step Accuracy (DNL) at 100 MHz

F1200 (Evaluation Board) - EB4313002
Step Error - 100 MHz

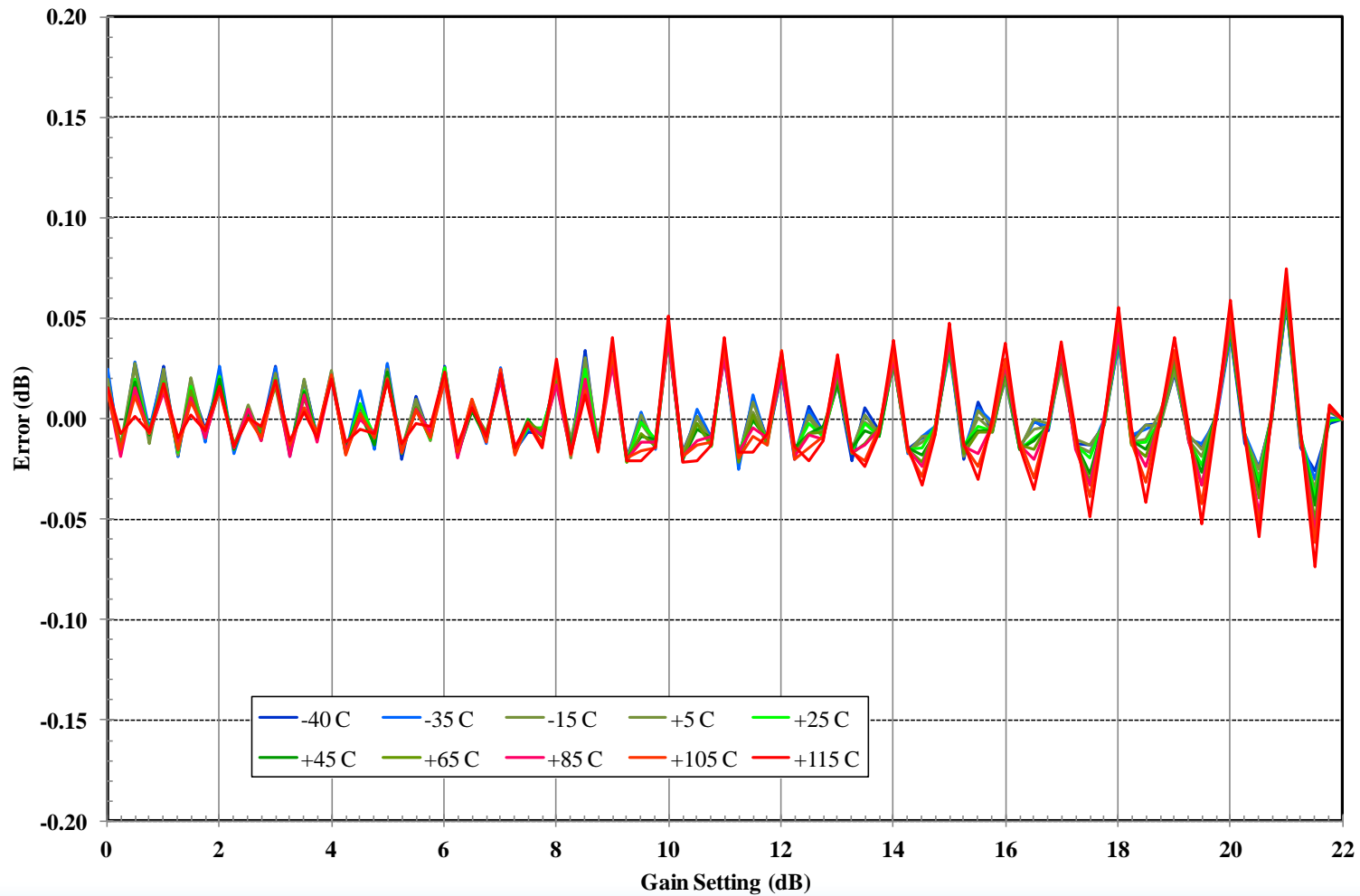

Step Accuracy (DNL) at 160 MHz

F1200 (Evaluation Board) - EB4313002
Step Error - 160 MHz

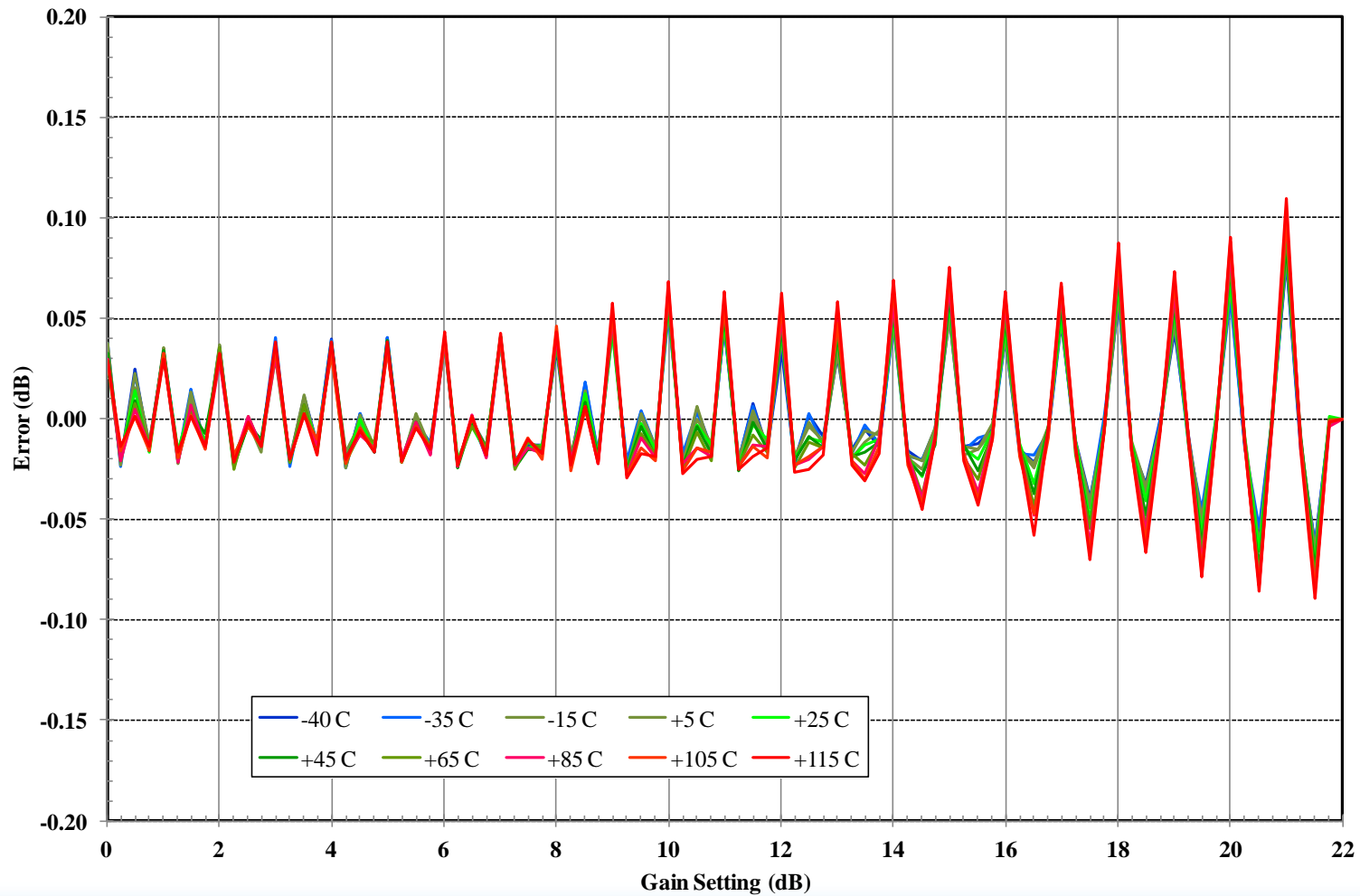

P1dB, IP3, Harmonic Test Setup

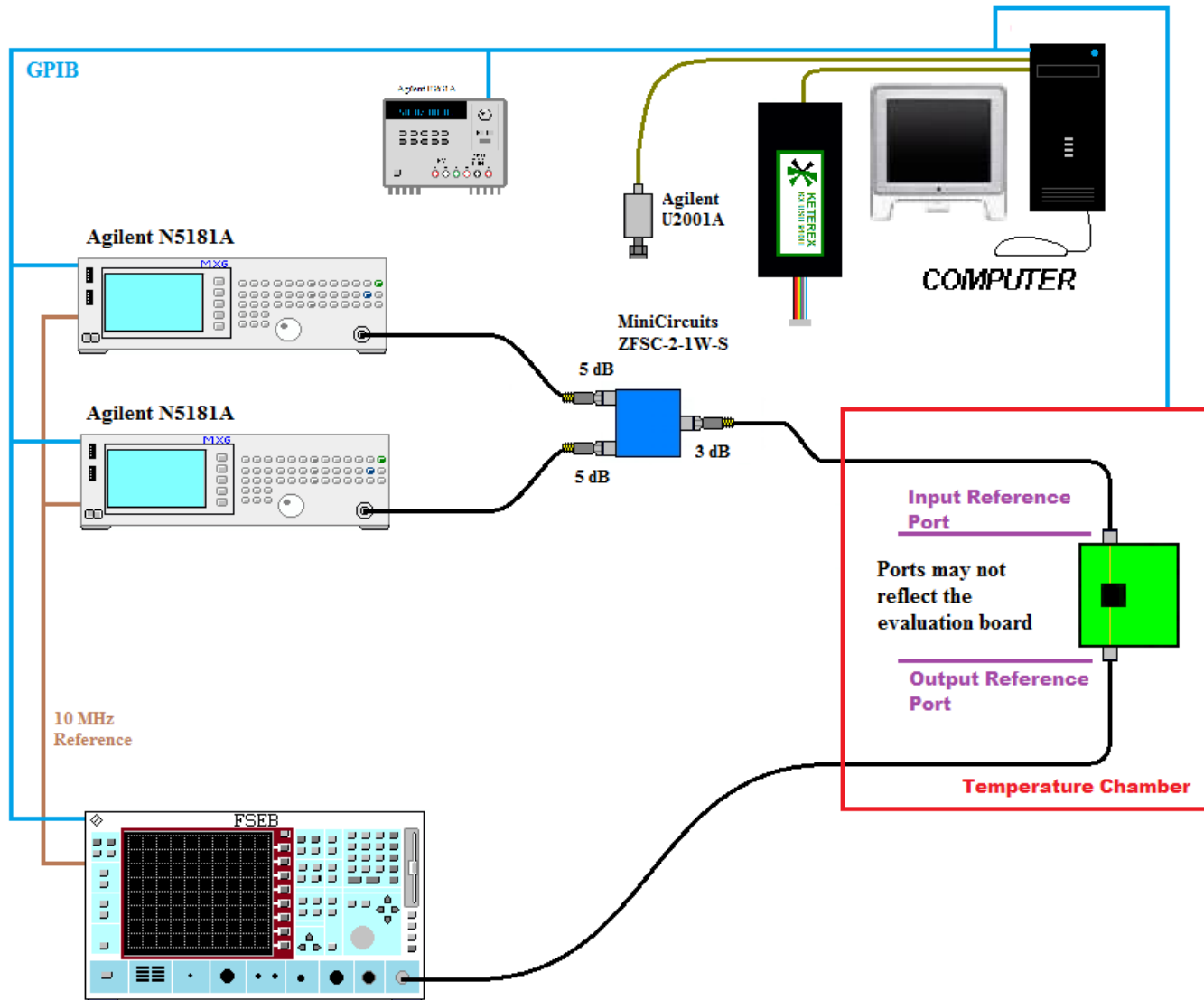

OP1dB: Maximum Gain

F1200 - Output 1 dB Compression
Vcc = 5.0 V, Maximum Gain Setting
Data is collected at the Evaluation Board Connectors

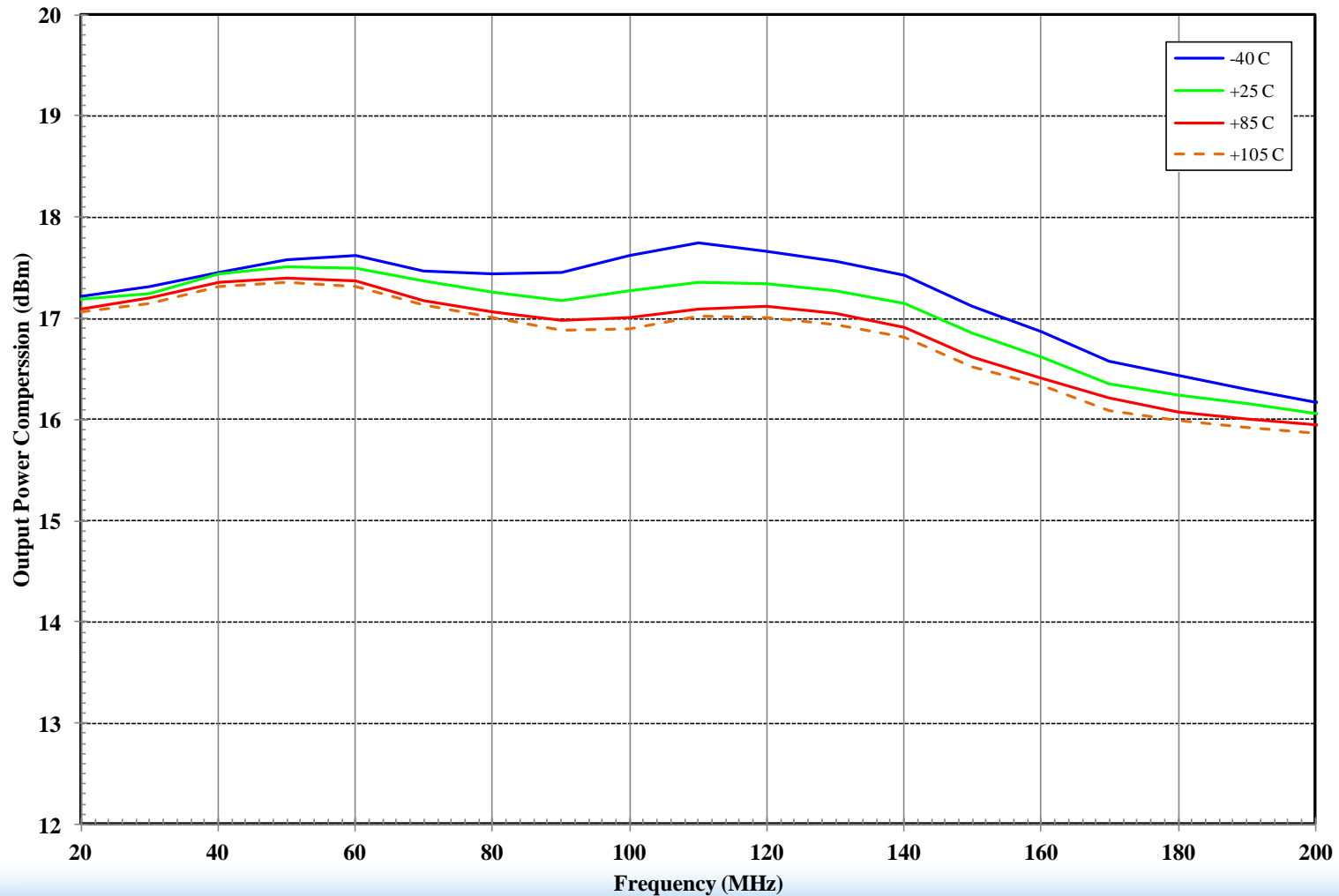

OP1dB: 50 MHz

F1200 - Output 1 dB Compression

Vcc = 5.0 V, 50 MHz

Data is collected at the Evaluation Board Connectors

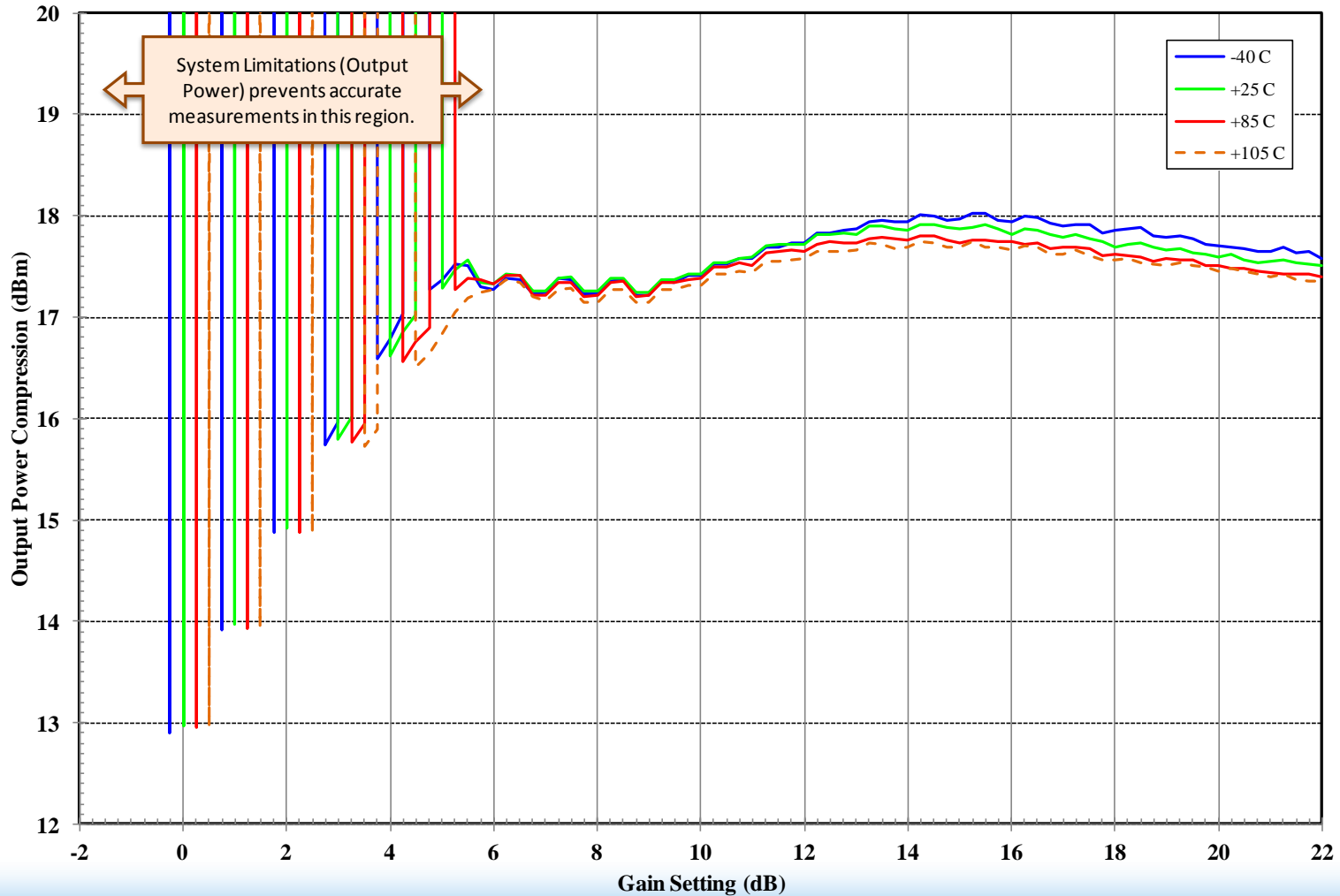

OP1dB : 100 MHz

F1200 - Output 1 dB Compression
Vcc = 5.0 V, 100 MHz

Data is collected at the Evaluation Board Connectors

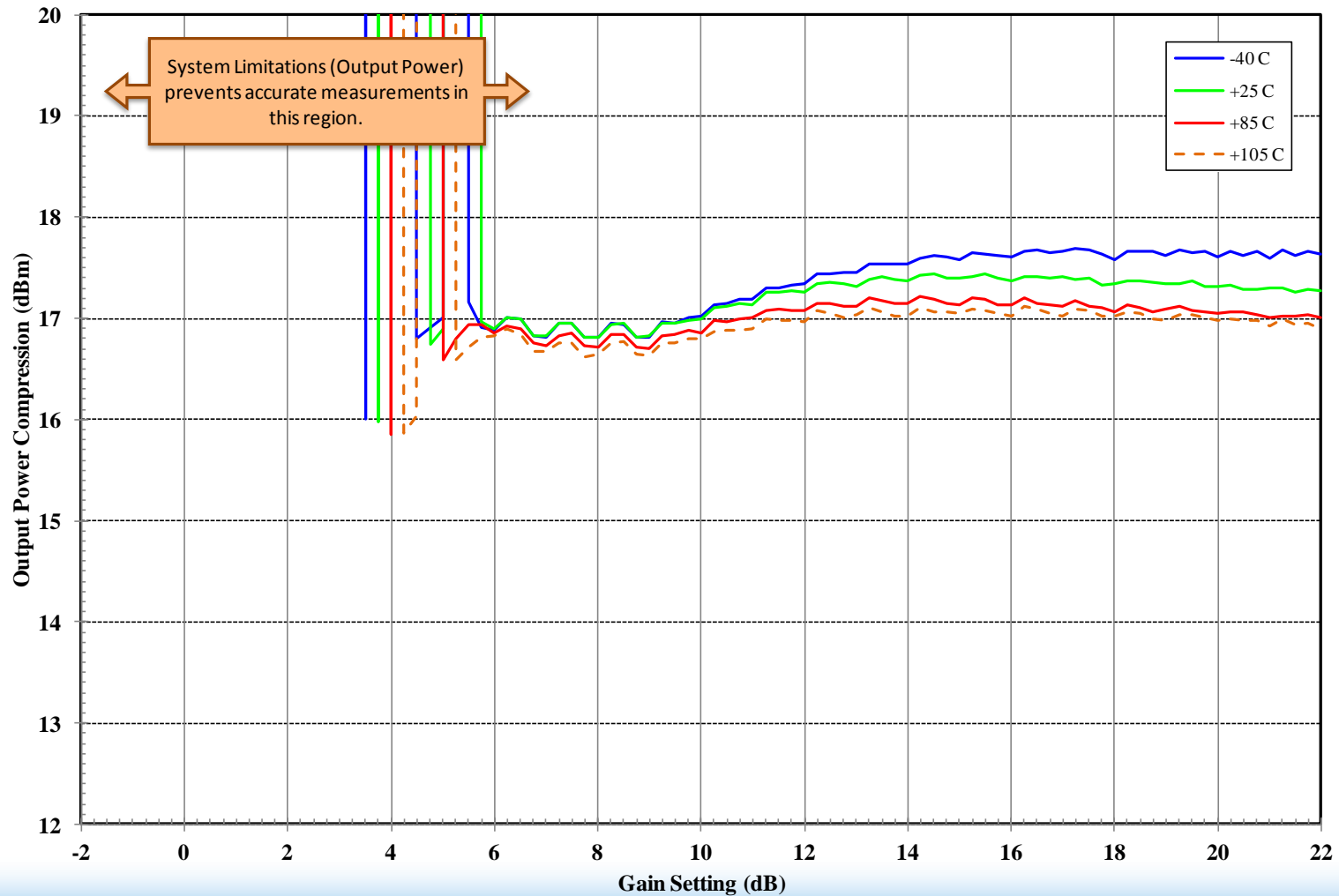

OP1dB : 160 MHz

F1200 - Output 1 dB Compression
Vcc = 5.0 V, 160 MHz

Data is collected at the Evaluation Board Connectors

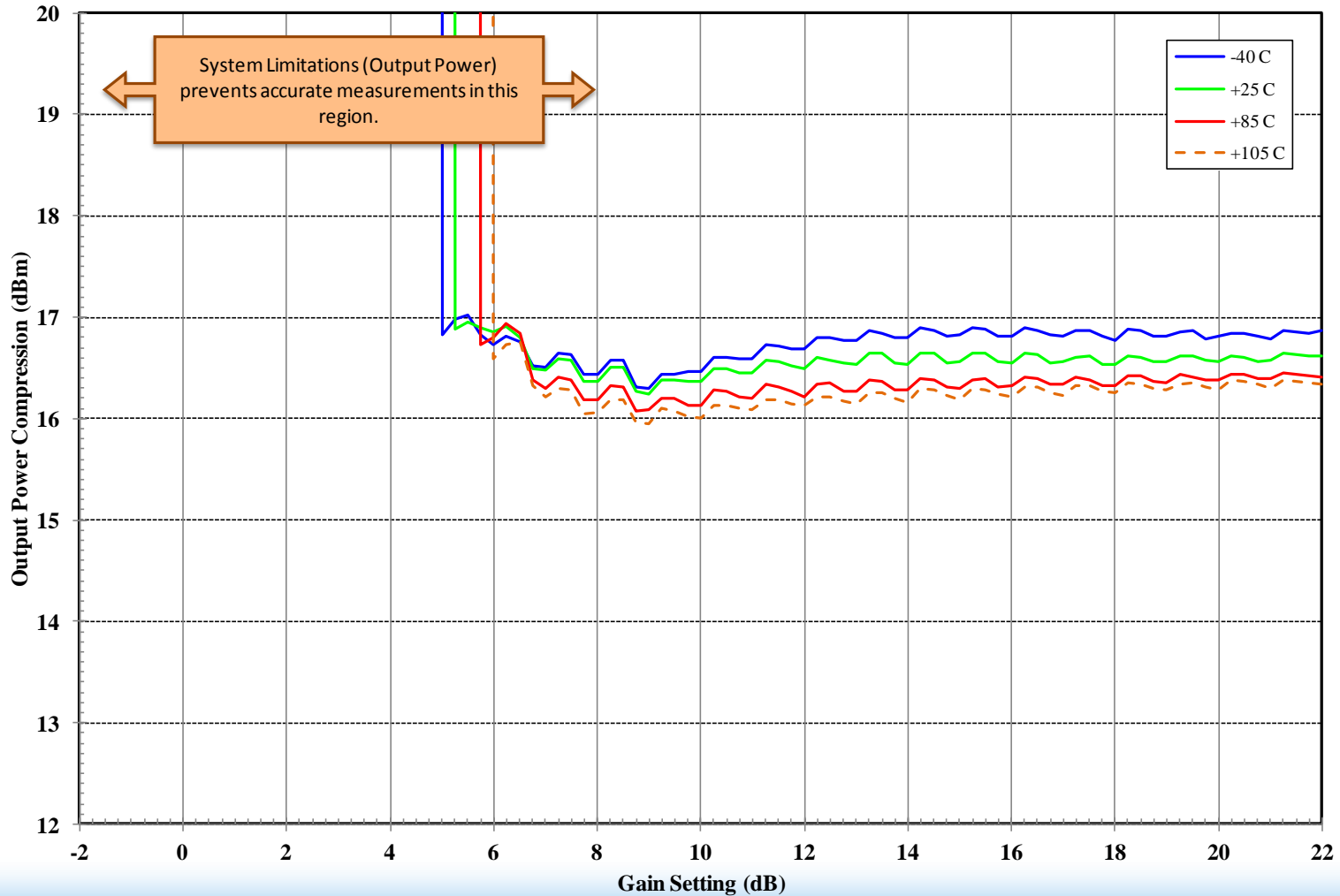

OIP3: Maximum Gain

F1200 - Output IP3
Vcc = 5.0 V, Maximum Gain Setting, Pout = 0 dBm
Data is collected at the Evaluation Board Connectors

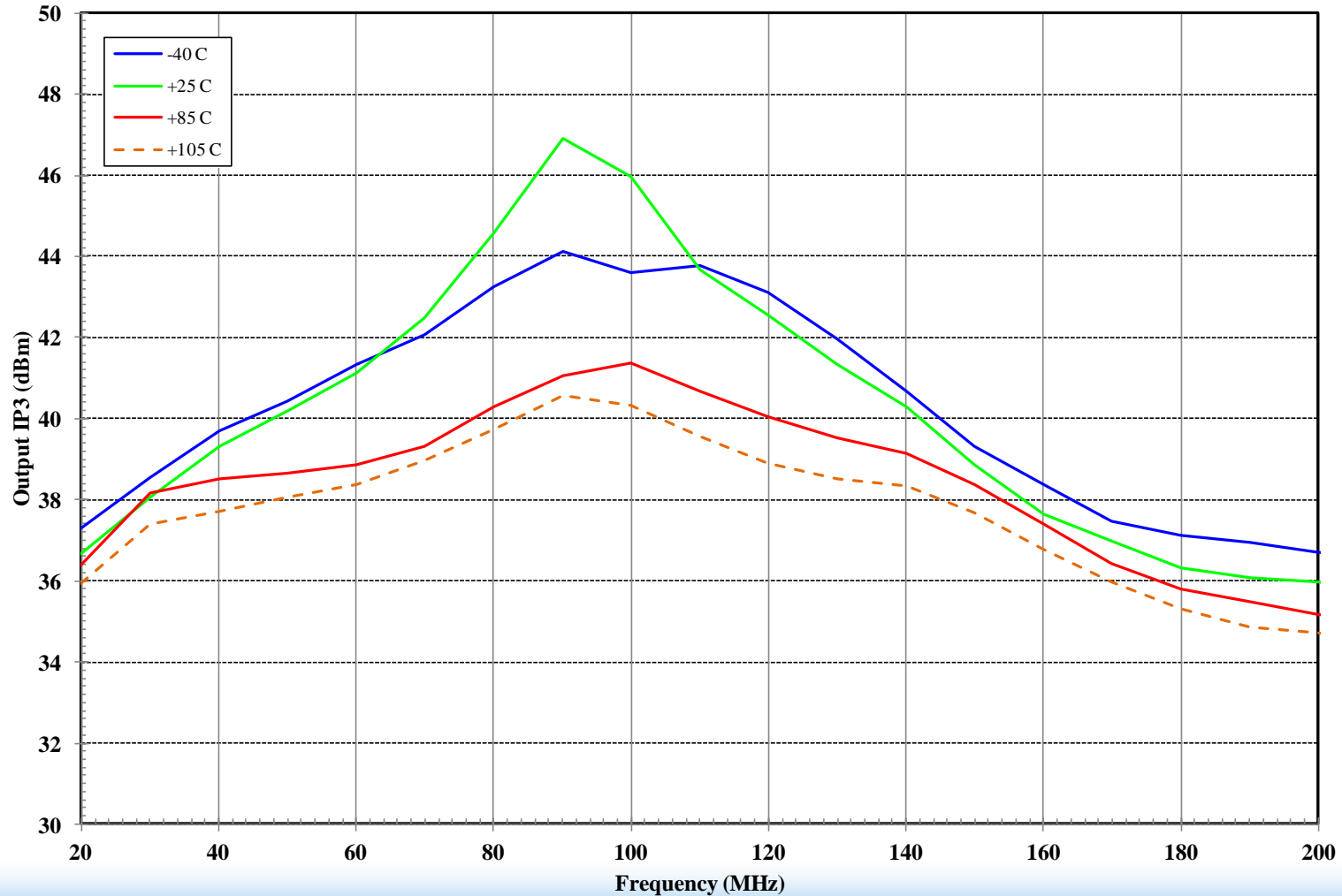

OIP3: 50 MHz

F1200 - Output IP3
Vcc = 5.0 V, 50 MHz, Pout = 0 dBm
Data is collected at the Evaluation Board Connectors

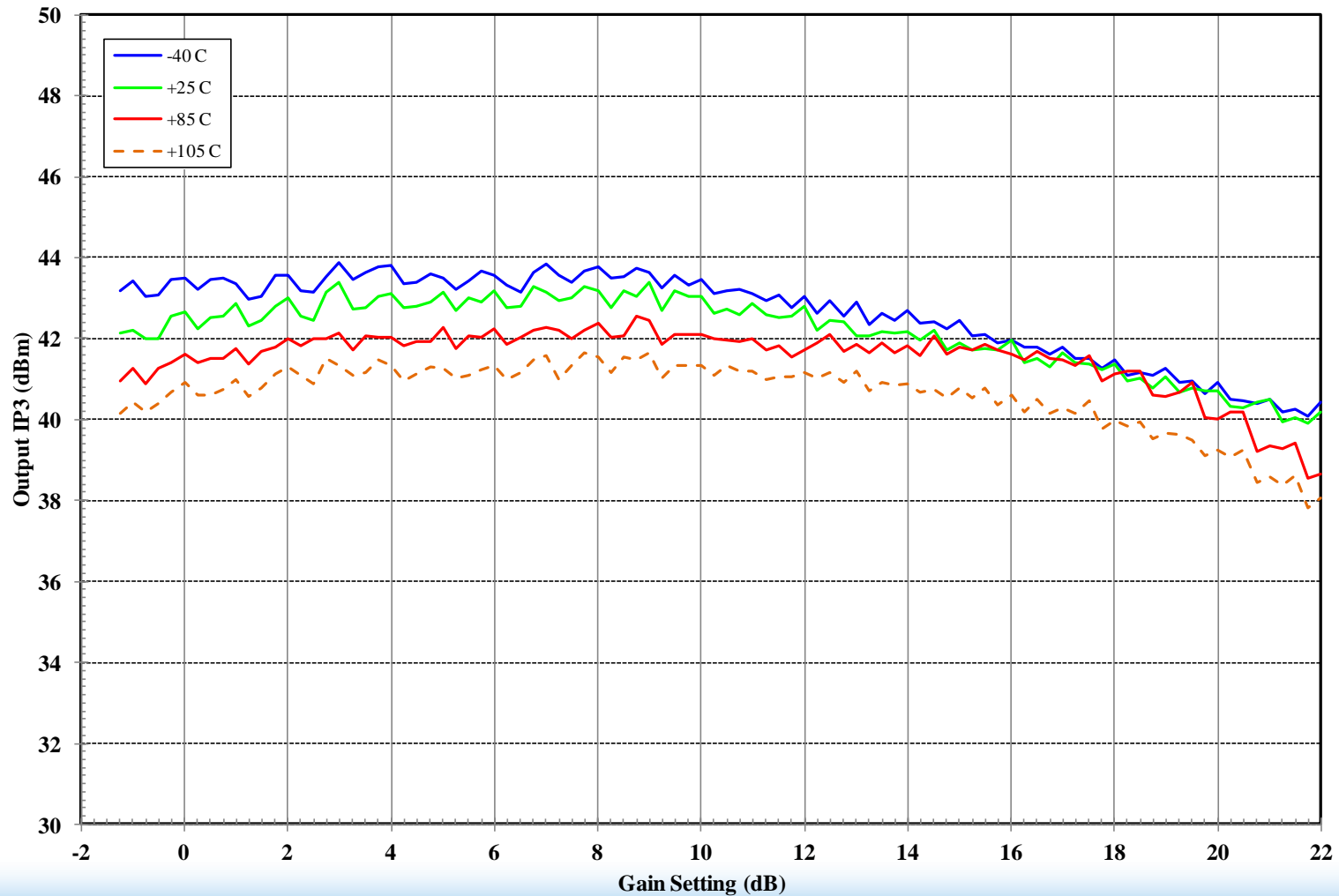

OIP3: 100 MHz

F1200 - Output IP3
Vcc = 5.0 V, 100 MHz, Pout = 0 dBm
Data is collected at the Evaluation Board Connectors

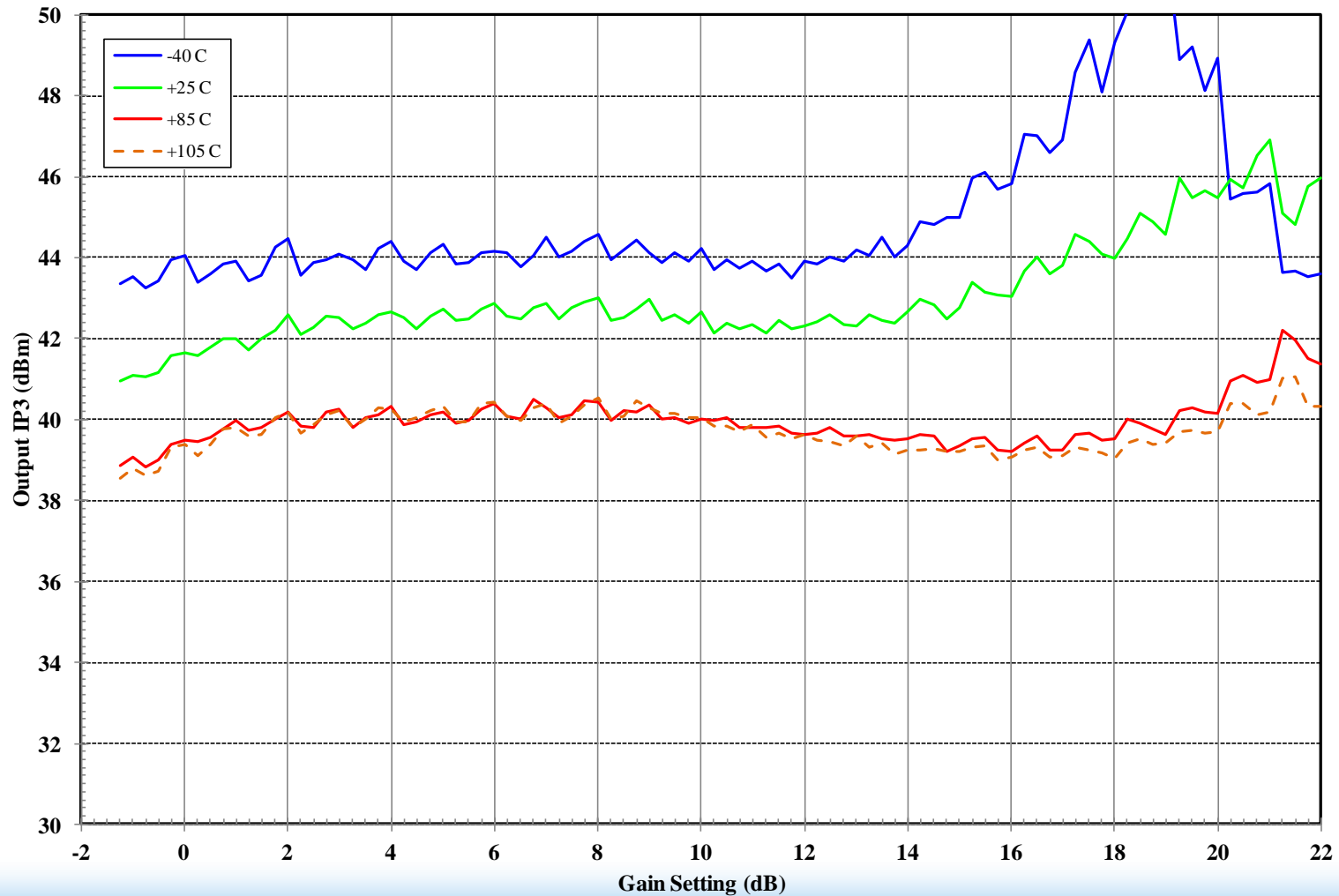

OIP3: 160 MHz

F1200 - Output IP3
Vcc = 5.0 V, 160 MHz, Pout = 0 dBm
Data is collected at the Evaluation Board Connectors

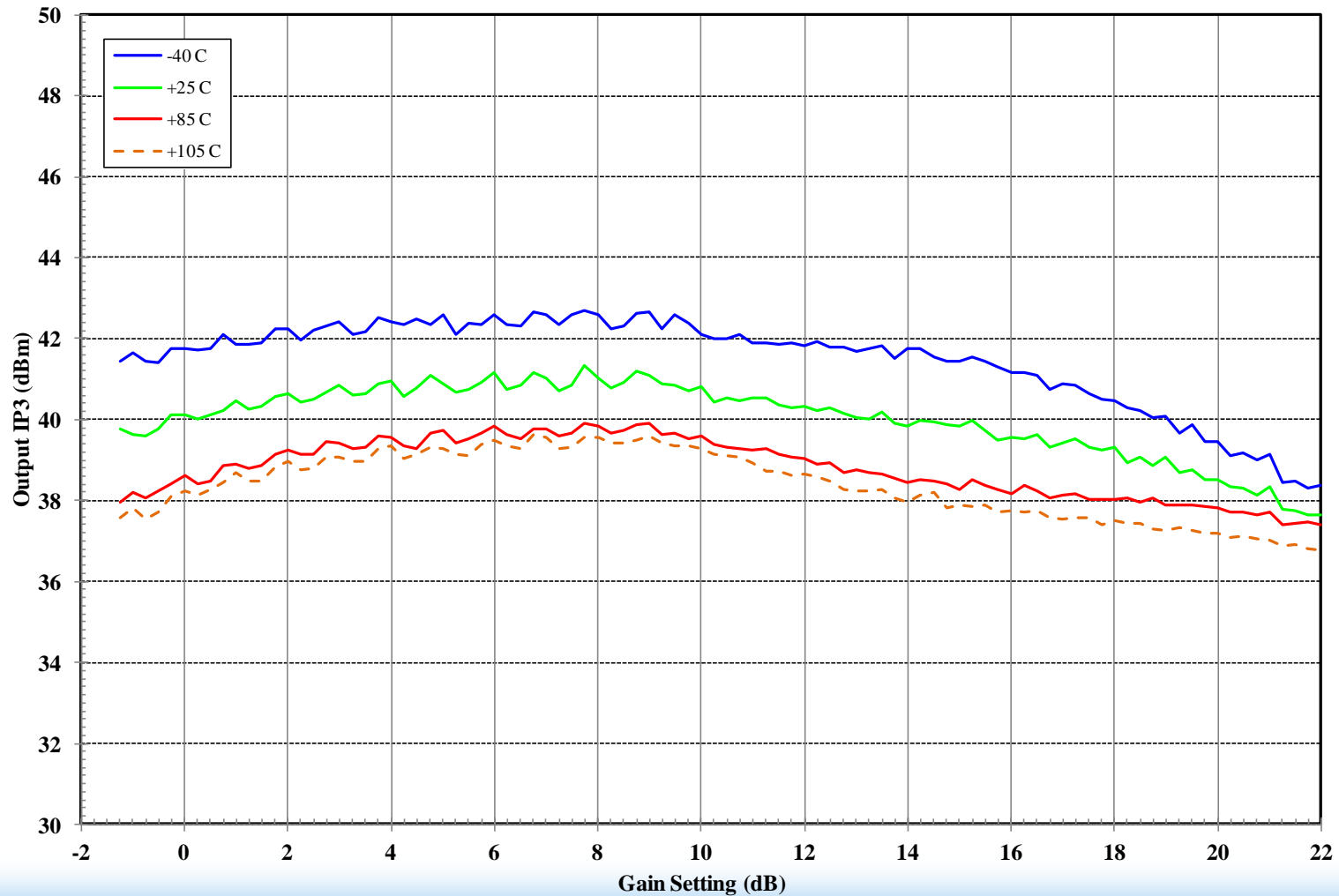

2nd Harmonic: Maximum Gain

F1200 - Second Harmonic
V_{cc} = 5.0 V, Maximum Gain Setting, P_{out} = 0 dBm
Data is collected at the Evaluation Board Connectors

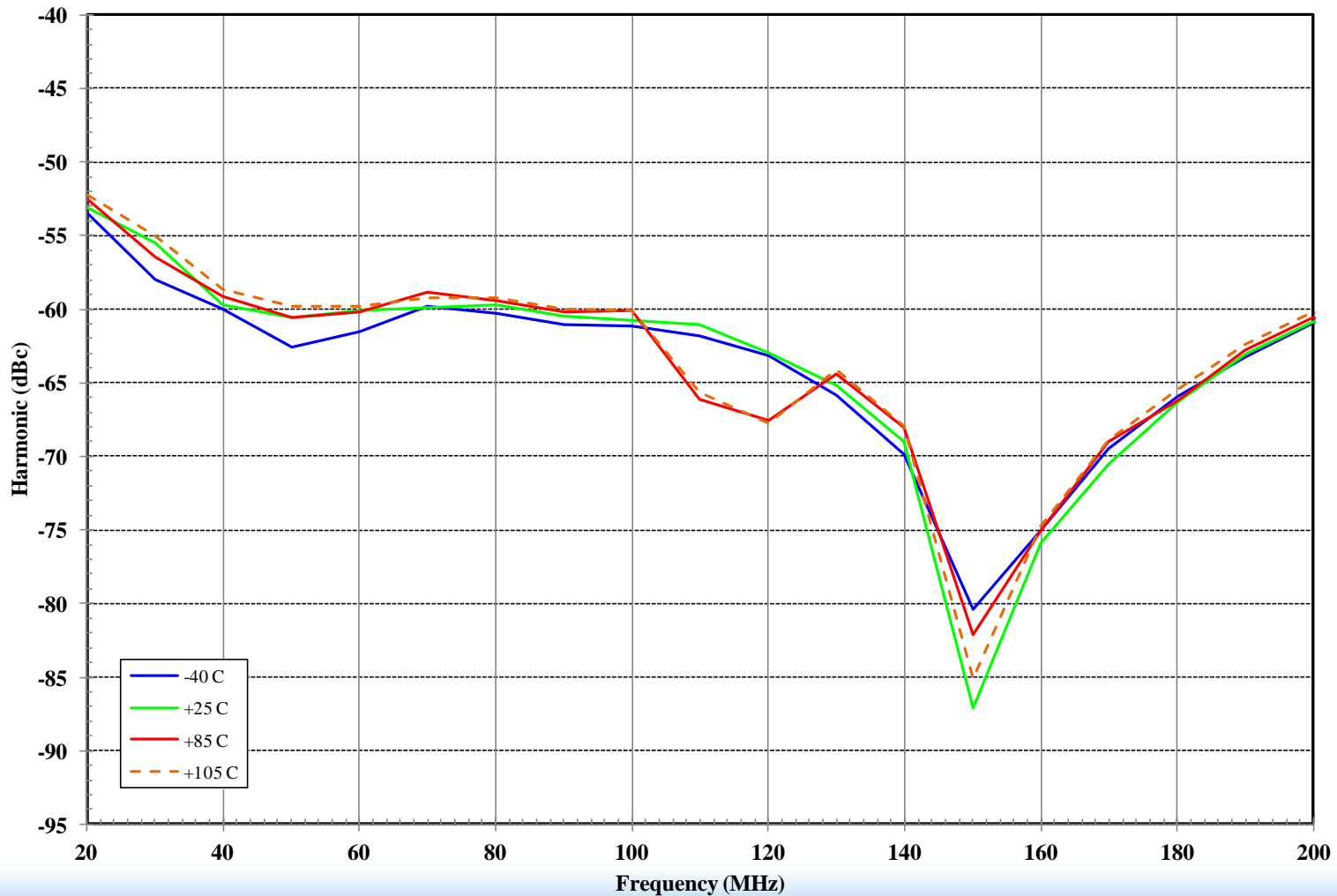

2nd Harmonic: 50 MHz

F1200 - Second Harmonic
V_{cc} = 5.0 V, 50 MHz, P_{out} = 0 dBm
Data is collected at the Evaluation Board Connectors

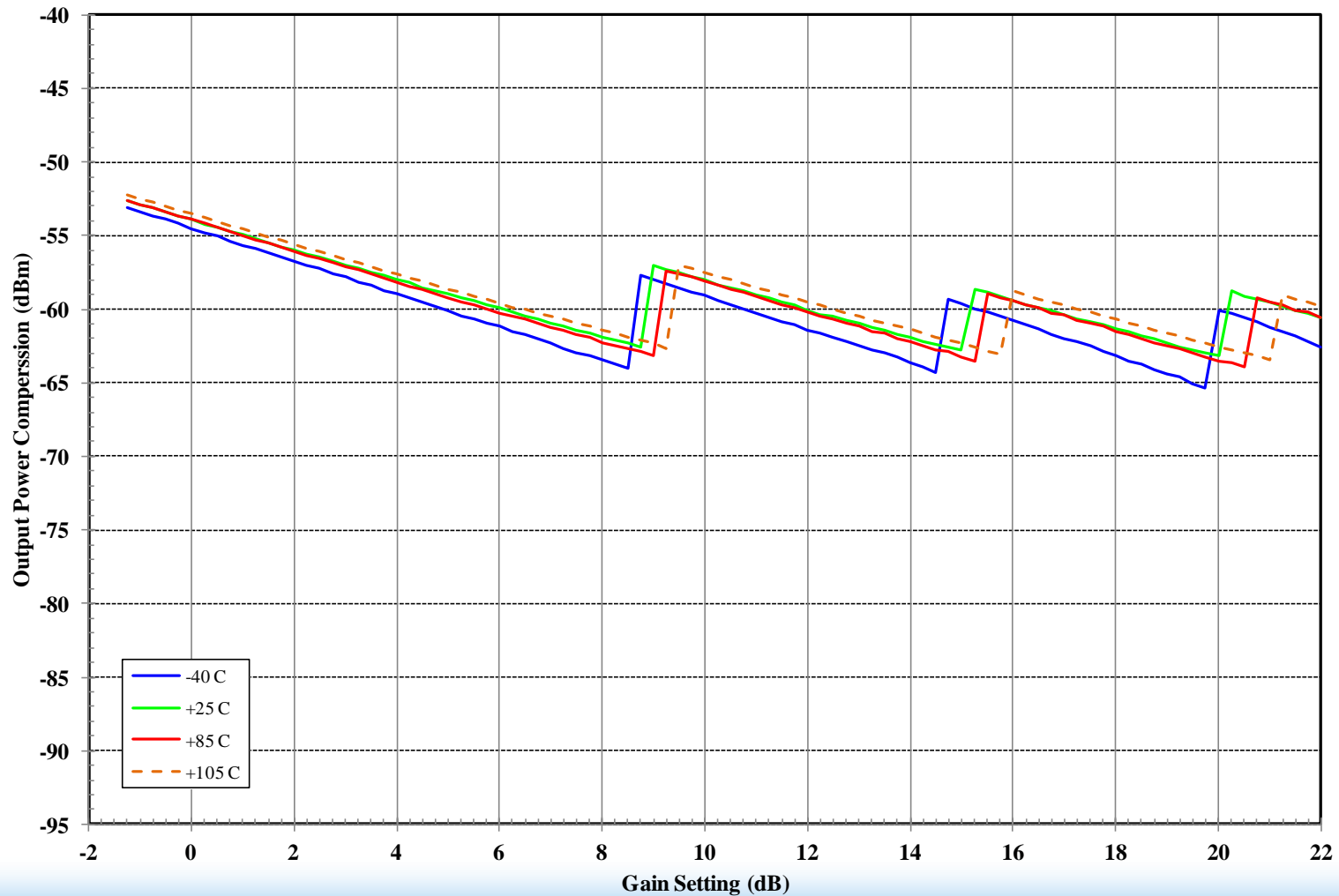

2nd Harmonic: 100 MHz

F1200 - Second Harmonic
V_{cc} = 5.0 V, 100 MHz, P_{out} = 0 dBm
Data is collected at the Evaluation Board Connectors

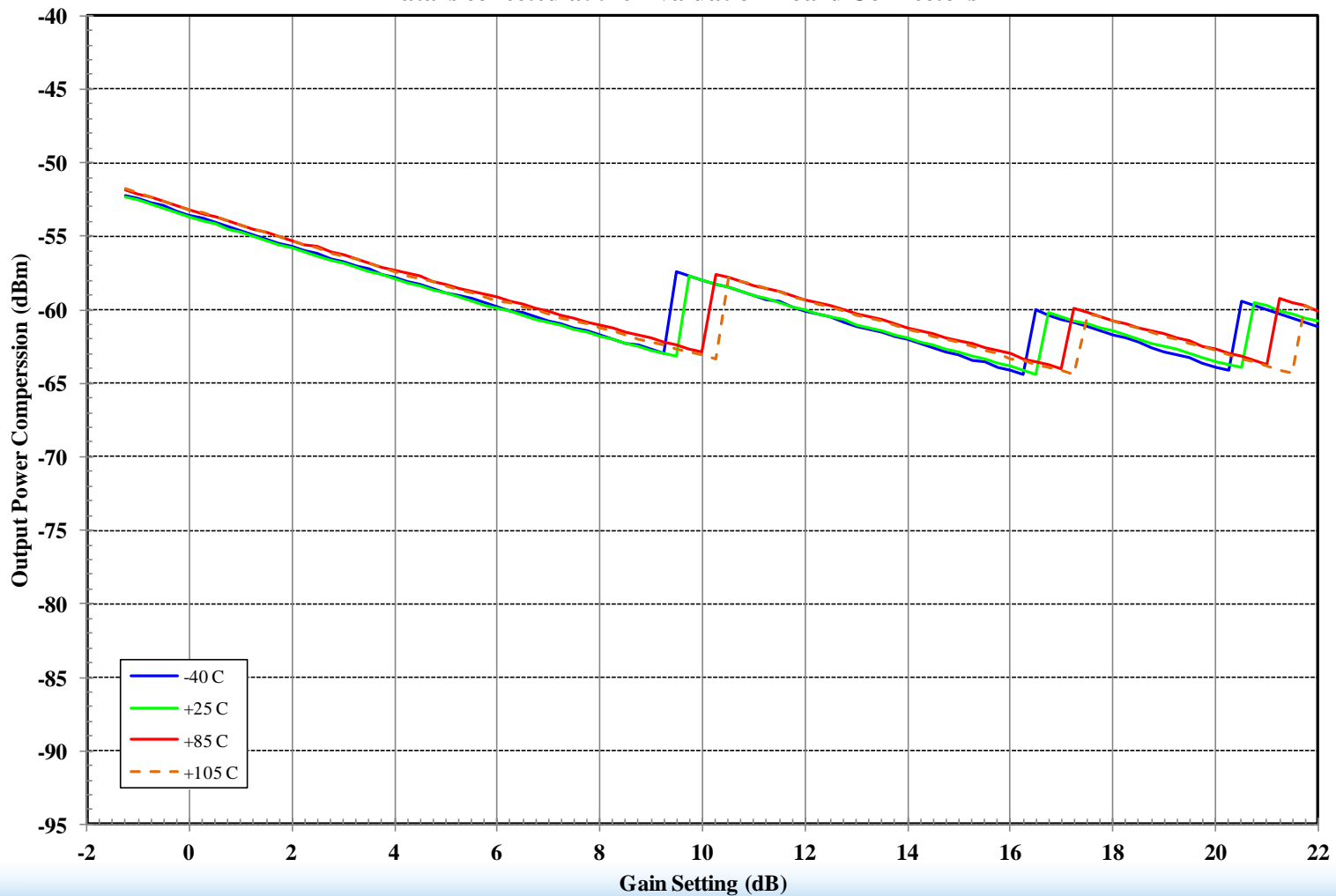

2nd Harmonic: 160 MHz

F1200 - Second Harmonic
Vcc = 5.0 V, 160 MHz, Pout = 0 dBm
Data is collected at the Evaluation Board Connectors

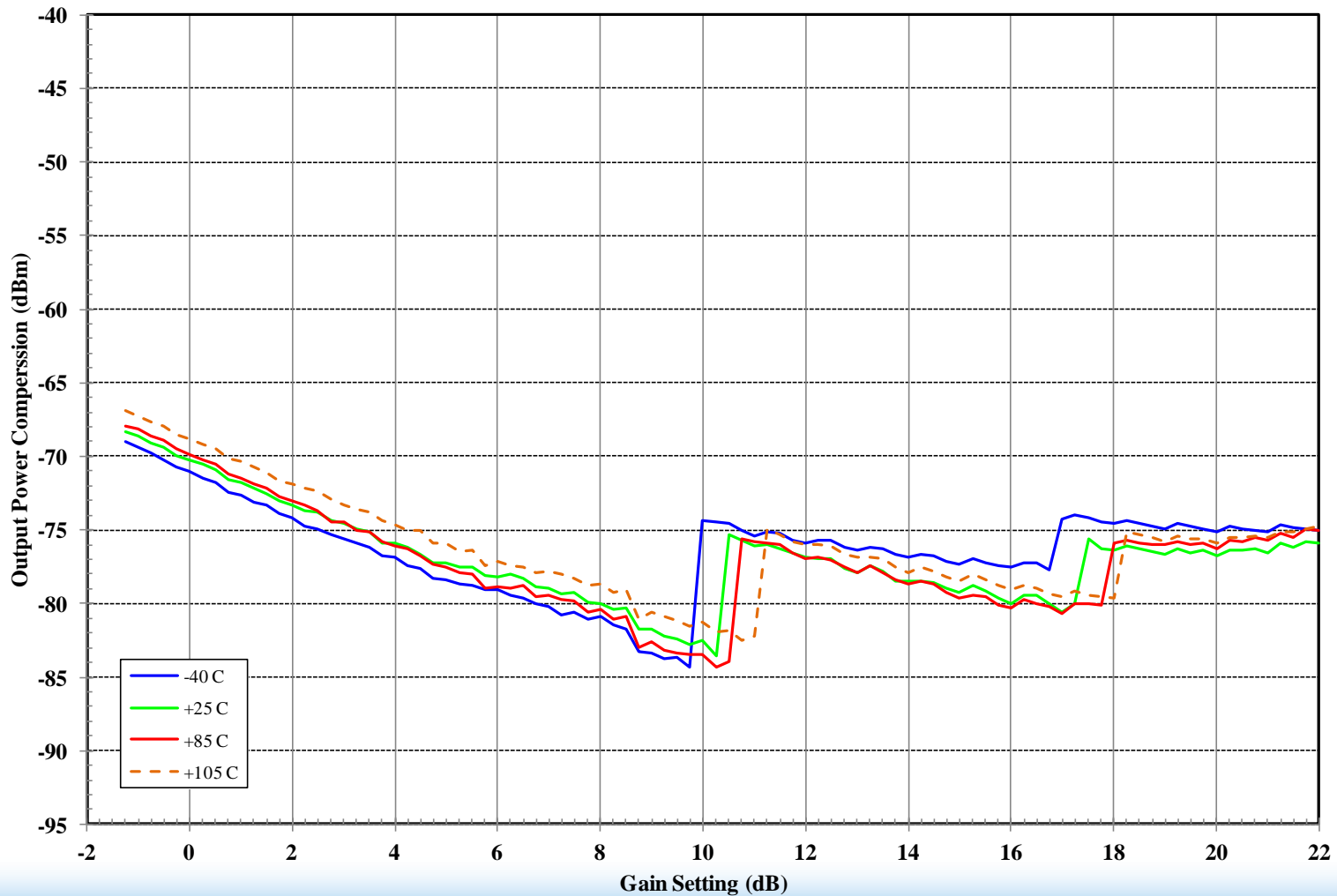

Noise Figure Test Setup

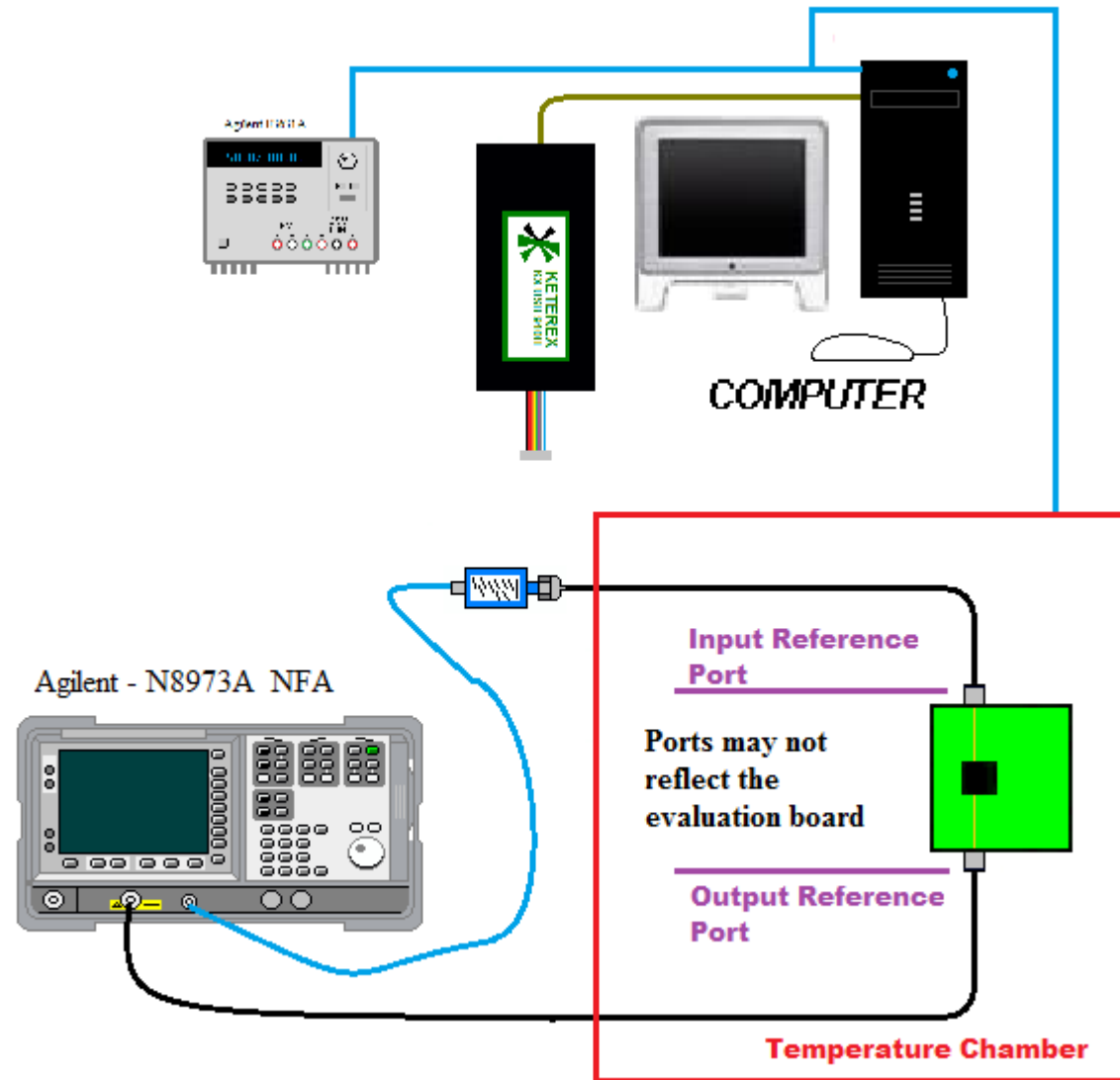

Noise Figure: Maximum Gain

F1200 - Noise Figure
+5.00 V, Maximum Gain
Data measured at the Evaluation Board connectors

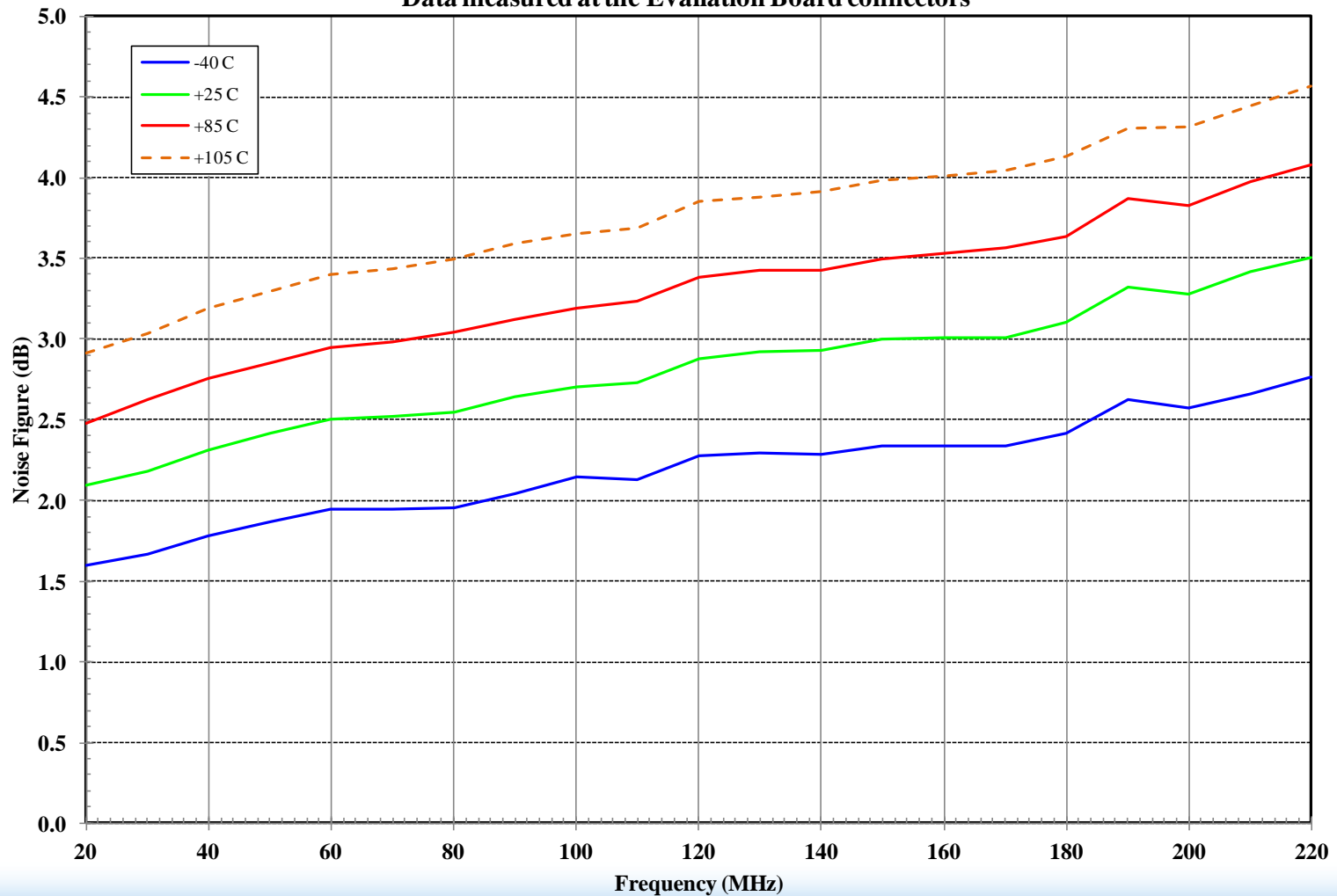

Noise Figure: 50 MHz

F1200 - Noise Figure
+5.00 V, 50 MHz
Data measured at the Evaluation Board connectors

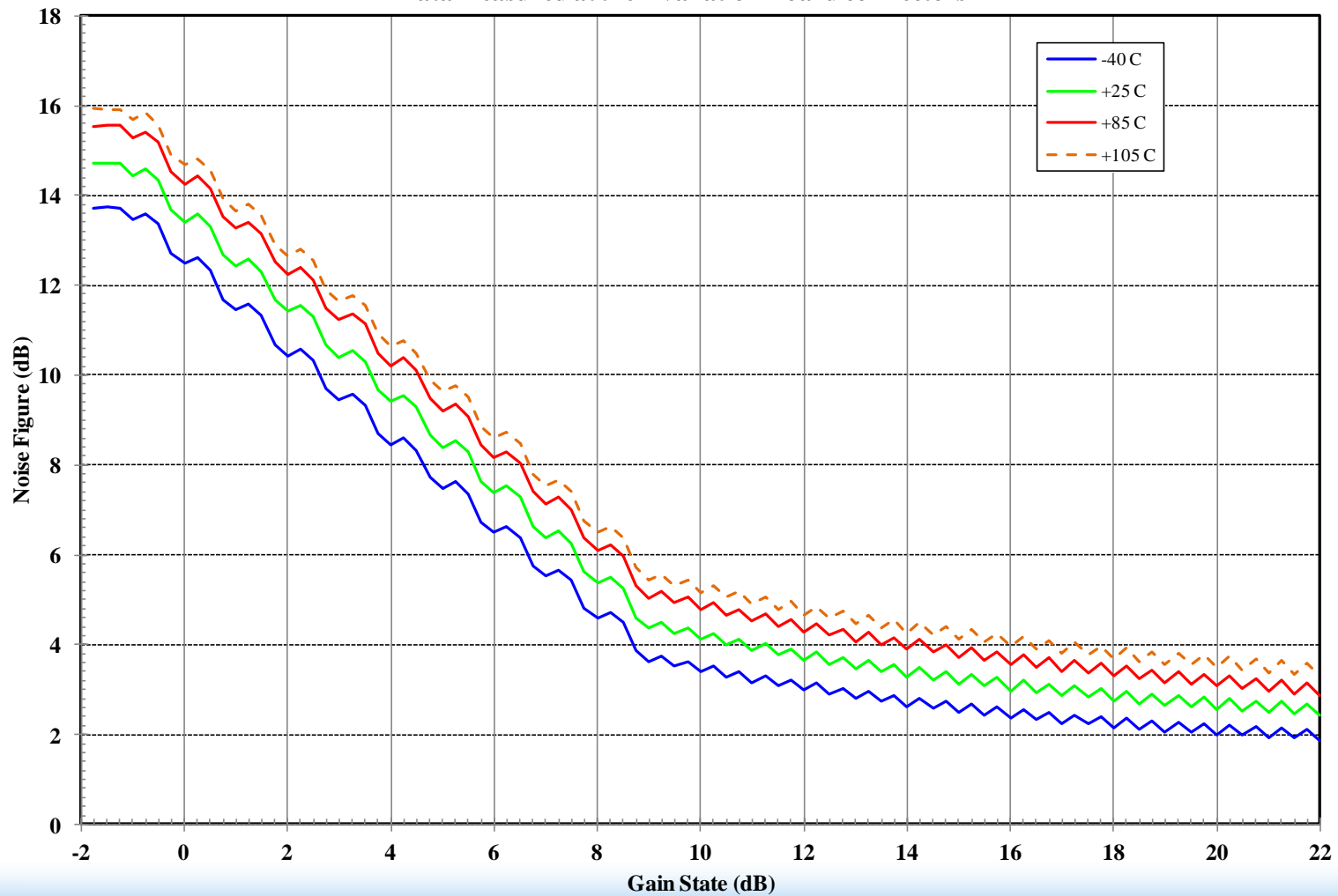

Noise Figure: 100 MHz

F1200 - Noise Figure
+5.00 V, 100 MHz
Data measured at the Evaluation Board connectors

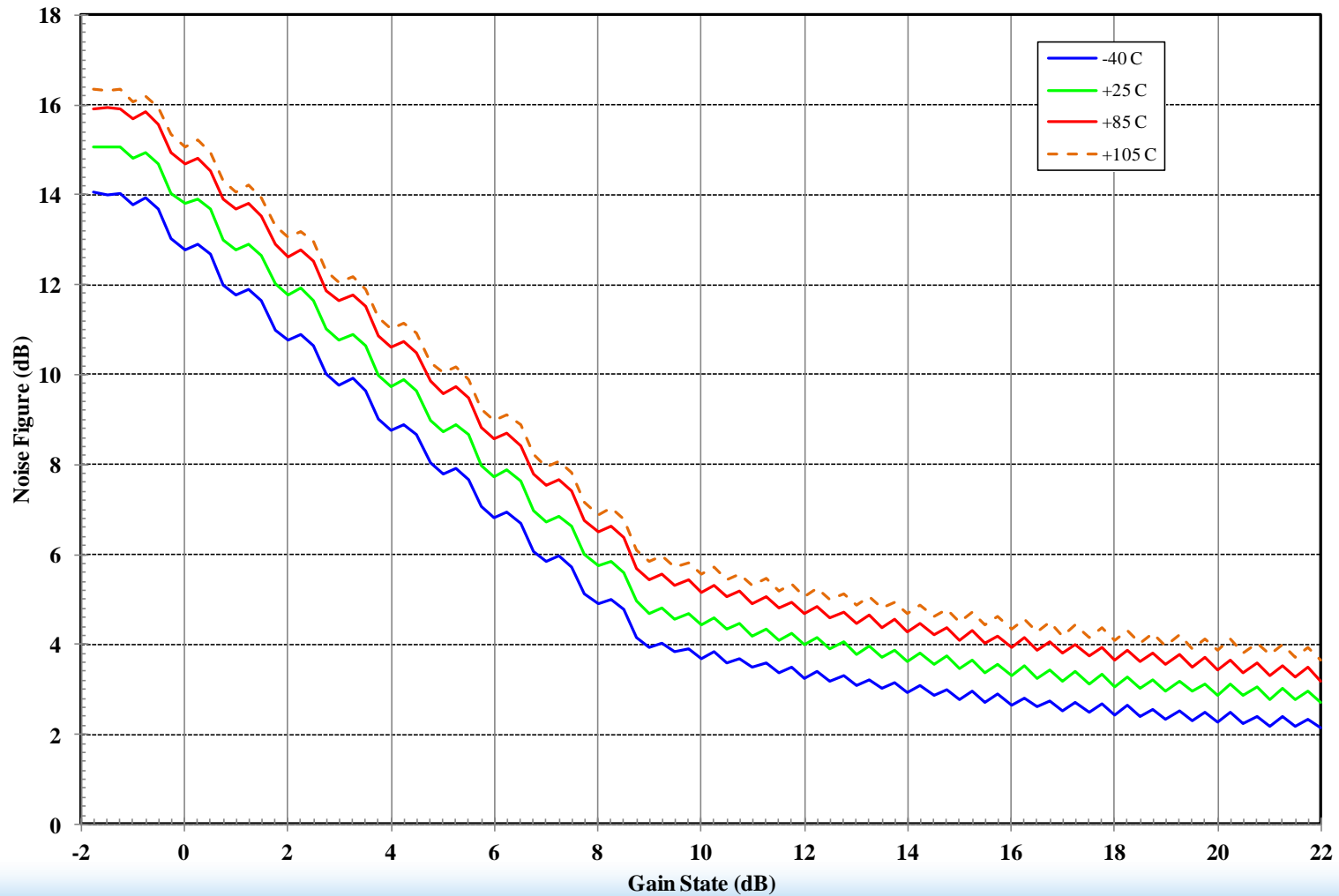

Noise Figure: 160 MHz

F1200 - Noise Figure
+5.00 V, 160 MHz
Data measured at the Evaluation Board connectors

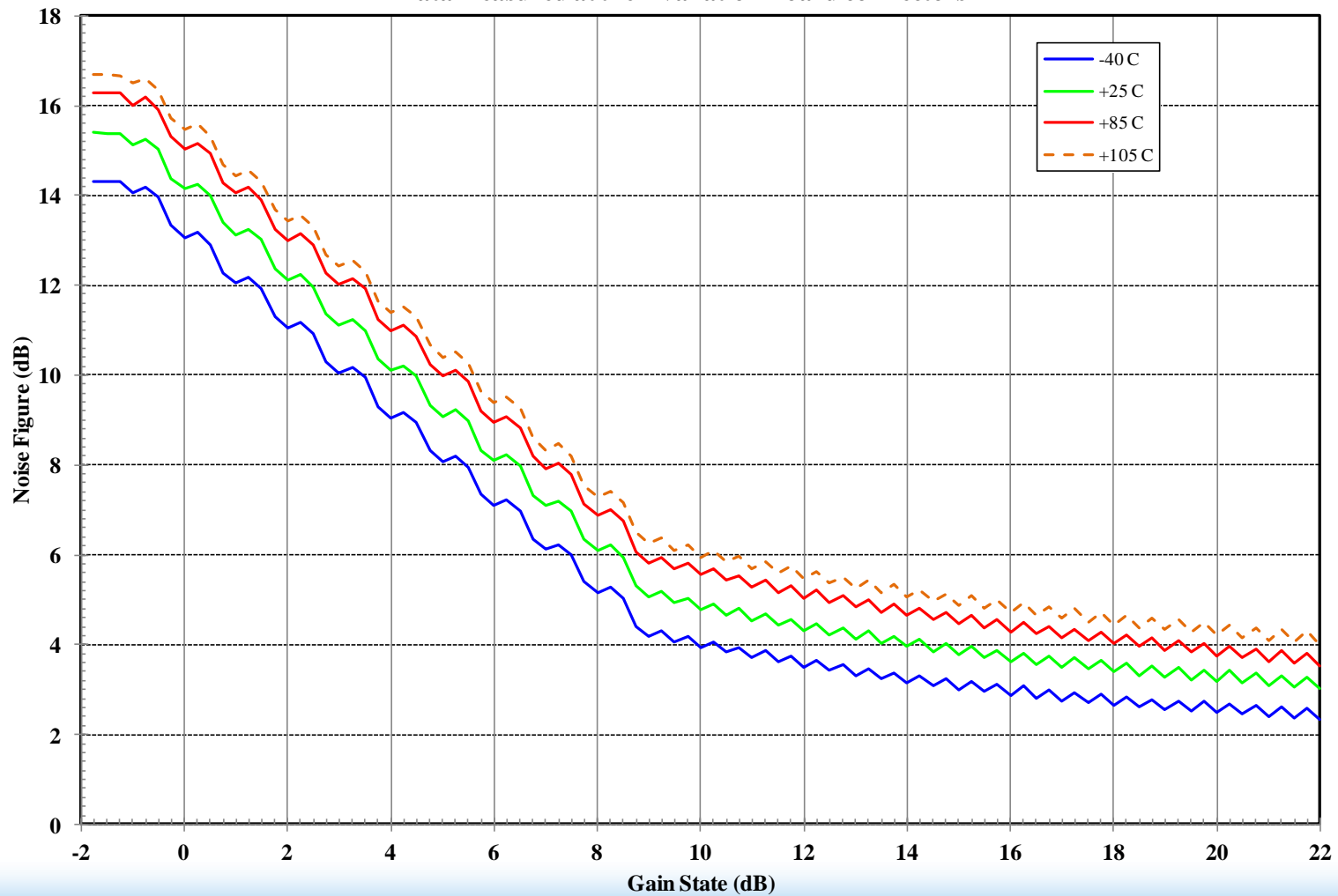

Conclusion

- Data was taken at -45, +25, +85, and +105 °C.
- Data shows that there is a nominal change from +85 to +105 C for all parameters.
- Use of the product for **LONG PERIODS** of time beyond 85 °C will increase the failure rate and is **NOT RECOMMENDED**.

